

# Agri Drain

CORPORATION

Your Partners in Water Management



See pages 4, 5, & 6.

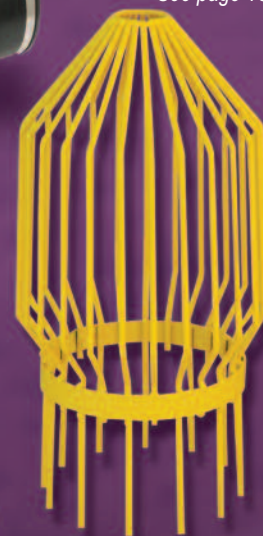

See page 16.



See page 37.

*America's most complete manufacturer and supplier of products for drainage water management, sub-irrigation, wetlands, ponds, lakes, erosion control, and land improvements.*

**2023 Vol. 1, No.1**

Prices subject to change without notice.

**Dear Land Improvement and Water Management Professionals,**

Check out my old FFA jacket! I can still put it on but can't zip it up. It was handed down to me from my older brother, Bill. He was a partner in Agri Drain for many years along with brother, Chris. Bill passed away this last December and we miss him a lot.



My guess is that many of our customers were FFA members, or at least were familiar with the organization. As a senior at Adair-Casey High School, I served as VP of our chapter. I've always thought a lot about agriculture and expected that I would farm the "homeplace" where I grew up.

We still have the family farm and I ended up in agriculture by being involved in water management, instead of farming. Agriculture is an amazing industry with lots of opportunities and also a tremendous amount of risk associated with factors we can't control.

Here at Agri Drain, we try to help minimize the on-farm water related risk and maximize the long-term yield and profit potential by providing products to our customers for use in conservation and water management practices that make a huge difference in agronomic and environmental outcomes.

Working together, we can all help to reduce risk, increase yields, protect our natural resources and support the current and Future Farmers of America.

At your service,

Charlie Schafer, President  
charlie@agridrain.com  
Phone: 800-232-4742  
Cell: 515-250-8479



 **MADE IN THE USA** Look for this flag beside products throughout the catalog. This symbol indicates the product is proudly made in the USA, and/or manufactured at our plant in Adair, Iowa.

**TABLE OF CONTENTS**

**Structures, Valves, & Gates ..... 3–11**

- |  |                      |
|--|----------------------|
| Manual Inlet Water Level Control Structure™  | Stoplog Retainer     |
| Ultra Lube                                   | V-Notch Weirs        |
| Fish Screens                                 | Water Gates          |
| Manual Inline Water Level Control Structure™ | Check Valves         |
| Smart Drainage System®                       | Valterra Gate Valves |
|  | Slide Gate Valves    |
|  | Flap Gates           |

**Pipe & Accessories ..... 12–15**

- |                           |                   |
|---------------------------|-------------------|
| Plastic Tubing & Fittings | Amazing Tile Tape |
| Corrugated Metal Pipe     | Anti-Seep Collars |
| Heavy Duty Lid            | Pipe Connectors   |
| Pipe Straps               | External Guards   |
| EZTee                     | Rat Guards        |
| Tile Cutters              |                   |

**Surface Inlets ..... 16–25**

- |                      |                      |
|----------------------|----------------------|
| Bar Guards           | Plastic Intakes      |
| Anti-Vortex Plates   | Quick Drains         |
| Trash Racks          | Precision Intakes    |
| Grates               | Hickenbottom Intakes |
| Intake Marker Flags  | Steel Risers         |
| Tile Marker Signs    | Steel Intakes        |
| Water Quality Inlets | Catch Basins         |

**Service & Affiliates ..... 26–27**

- |              |                    |
|--------------|--------------------|
| Warranty     | Shipping           |
| Credit Terms | Custom Fabrication |

**Equipment & Tools ..... 28–31**

- |                        |                  |
|------------------------|------------------|
| Maxi Stringer Trailers | Shovels & Spades |
| Maxi Spools            | Mud Slingers     |
| Probes                 |                  |

**Survey Equipment ..... 32–34**

- |                               |                              |
|-------------------------------|------------------------------|
| Laser Transmitters with Grade | Hand Level                   |
| Survey Receivers              | Marking Paints & Accessories |
| Tripods                       | Flag Shooter & Flags         |
| Survey Rods                   | Survey Marking Flags         |
| Grade Gauges™                 |                              |

**Erosion Control ..... 35–36**

- |                               |            |
|-------------------------------|------------|
| Engineering Fabric            | Geojute    |
| Straw Blankets                | Silt Fence |
| Straw Wattle                  |            |
| Waterway Fabric Plow & Fabric |            |

**Pond & Lake Management ..... 37–38**

- |                           |                  |
|---------------------------|------------------|
| Watermaster Floating Pump | Connect-A-Dock   |
| Dry Hydrants              | Clean Check      |
| Pond & Lake Aerator       | Backwater Valves |
| Pond Liner                |                  |

**More Products Available Online**

# WATER MANAGEMENT PRACTICES

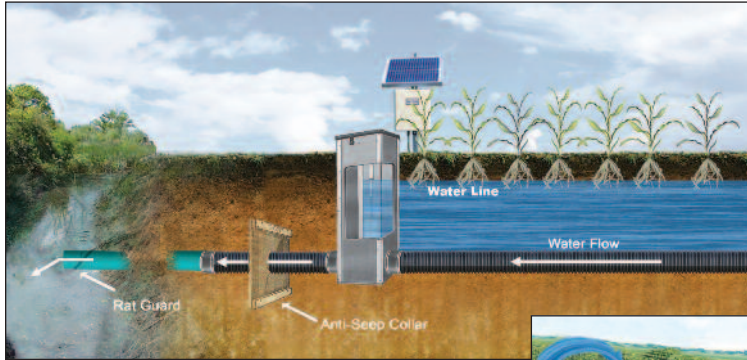

## Drainage Water Management

Drainage water management conserves water, increases yields, and reduces fertilizer and nutrient loss to streams by 30 to 50%. This practice is most cost effective on a 0–1% slope with mains installed on the steepest grades and laterals installed on the contour. Structures are then installed in the main every 1' to 2' of elevation change.

## Sub-Irrigation

A sub-irrigation system delivers water to your crop's root system, reduces crop stress during dry periods by adding water through your drainage system, and increases yields by as much as 64%.

Sub-irrigation works for odd-shaped fields that aren't practical for traditional overhead irrigation systems, increases water-use efficiency, and lowers irrigation energy bills.

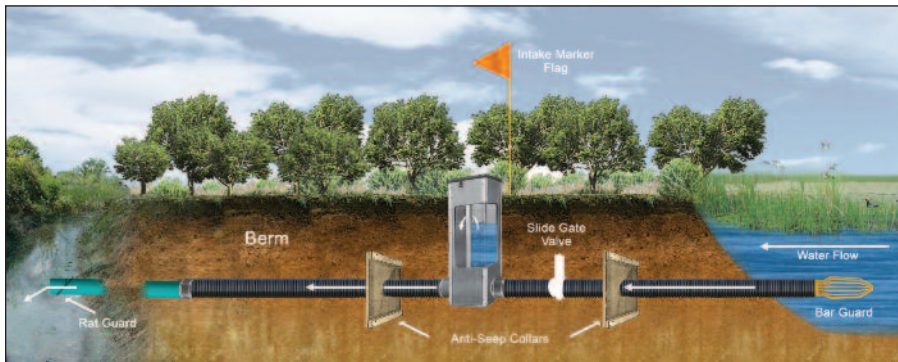

## Typical Pond & Wetland Installation

Including an overflow structure in your pond or wetland application keeps the water surface at the optimal level designed for the pond or for wildlife habitat in a wetland, while also allowing the ability to pull all the boards out, draining the water for pond maintenance.

## Saturated Buffer

Locating a saturated buffer along or in a vegetated area made up of grasses, shrubs, and trees between the cropland field and the watercourse, reduces sediment and phosphorous carried by surface runoff and nitrates below surface from entering streams. Nitrate reductions of 50 to 90% are not uncommon. As the water flows through the buffer, both denitrification and uptake by the perennial plants in the buffer remove nitrates and improve the quality of water flowing into the streams.

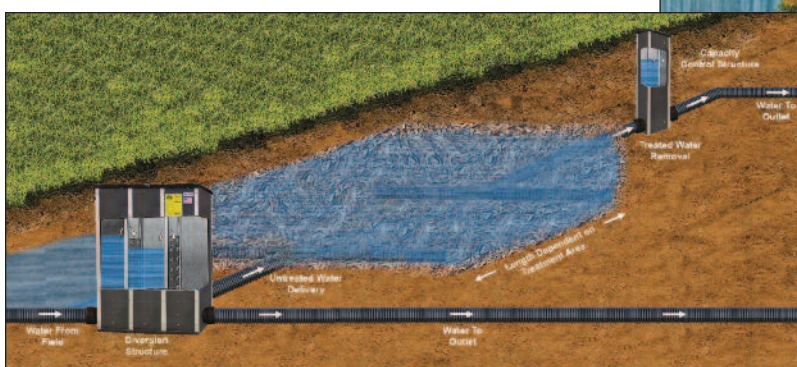
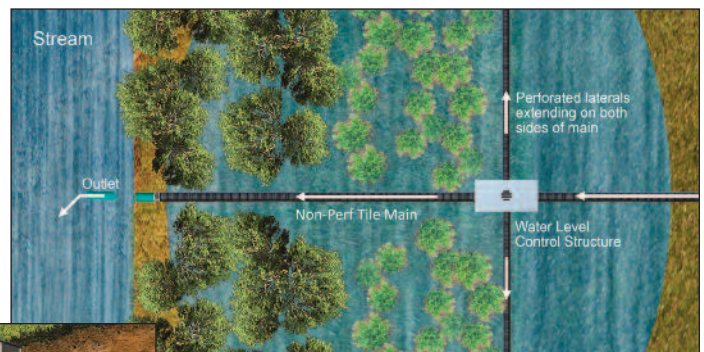

## Bioreactor

A bioreactor is a subsurface trench located along the edge of a field that is filled with a carbon source, most often woodchips. A water level control structure is used to divert field runoff through the trench to break down nitrate through denitrification processes converting it to nitrogen gas. The treated water then flows toward the outlet via another control structure.

# STRUCTURES, VALVES, & GATES

## MANUAL INLET WATER LEVEL CONTROL STRUCTURE™

- Constructed of rugged 1/2" PVC.
- Stainless steel screws and custom anodized aluminum corner extrusions used for strength and durability\*.
- Flexible coupler allows PVC, plastic pipe, or other materials to be easily attached. *(Please specify type of pipe when ordering.)*
- Stoplogs made of PVC in 5" and 7" heights for adjustability. (Maintenance recommended: Remove stoplogs and grease seal with Ultra Lube [included]. Ensure there is no debris in the tracks or along the bottom of the structure. Replace stoplogs after greasing.)
- To minimize seepage, align stoplogs against one side of the stoplog track.
- Stoplogs must remain in track during structure installation.
- Structures are intended for gravity flow only; some seepage may occur.
- 5-year warranty on all standard structures.

\*For water that is caustic, acid, corrosive, salt, or pH below 5 pH or above 9 pH, please notify us of your requirements to ensure structures are built with compatible hardware. For these applications, Agri Drain recommends stainless steel.



Structure must be anchored down when installed or it may have the tendency to float.

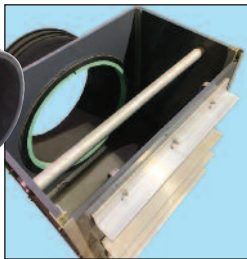

Bird's-eye view of the stoplogs in structure tracks.



## ULTRA LUBE

- Recommended for lubricating the seal on the stoplogs in our Water Level Control Structures.
- For maintenance, remove stoplogs and grease seal with Ultra Lube. Ensure there is no debris in the tracks or along the bottom of the structure. Replace stoplogs after greasing, ensuring bottom stoplog is installed first.

WCS Lube, 8 oz Tube Ultra Lube

INLET WATER LEVEL CONTROL STRUCTURE™		
Pipe Diameter	Inside Dimension Width x Depth	Heights Available
4"	11 <sup>5</sup> / <sub>8</sub> "W x 6"D	2', 3', 4', 5', 6'
6"	11 <sup>5</sup> / <sub>8</sub> "W x 6"D	2', 3', 4', 5', 6'
8"	11 <sup>5</sup> / <sub>8</sub> "W x 6"D	2', 3', 4', 5', 6'
10"	14"W x 8"D	2', 3', 4', 5', 6'
12"	16"W x 10"D	2', 3', 4', 5', 6'
15"	20"W x 12"D	2', 3', 4', 5', 6'
18"	24"W x 14"D	2', 3', 4', 5', 6'
24"	31"W x 18"D	3', 4', 5', 6'

Box width reflects the coupler side panel of structure. Larger CMP structures also available. Call for details on custom sizes and pricing.

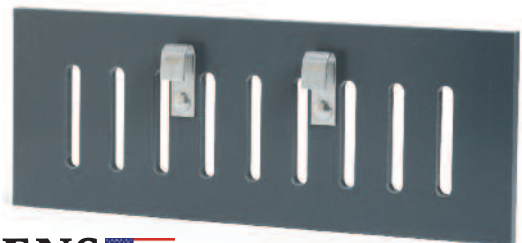

## FISH SCREENS

*Eliminate expensive fish loss with our Fish Screens.*

- Fish Screens can be used in either an Inline or Inlet Water Level Control Structure™ to keep your aquatic life safe, while allowing water to flow through the structure.
- Constructed of rugged 1/2" PVC with 1/2" wide slots.
- Save your fish—buy a Fish Screen today!

FISH SCREENS		
Size	Item#	Description
7 <sup>3</sup> / <sub>4</sub> "W x 6"H	FS0406	4" / 6" Fish Screen
11 <sup>1</sup> / <sub>4</sub> "W x 6"H	FS08	8" Fish Screen
13 <sup>3</sup> / <sub>4</sub> "W x 6"H	FS10	10" Fish Screen
15 <sup>3</sup> / <sub>4</sub> "W x 6"H	FS12	12" Fish Screen
19 <sup>3</sup> / <sub>4</sub> "W x 6"H	FS15	15" Fish Screen
23 <sup>3</sup> / <sub>4</sub> "W x 6"H	FS18	18" Fish Screen
30 <sup>3</sup> / <sub>4</sub> "W x 6"H	FS24	24" Fish Screen

Item# FS0406 fits Inline Structures only. For Inlet Structures with 4" or 6" pipe size, use item# FS08.

More details available online at [www.agridrain.com](http://www.agridrain.com)

INLINE WATER LEVEL CONTROL STRUCTURE™		
Pipe Diameter	Inside Dimension Width x Depth	Heights Available
4"	8"W x 10"D	2', 3', 4', 5', 6', 8', 10', 12'
6"	8"W x 10"D	2', 3', 4', 5', 6', 8', 10', 12'
8"	11 <sup>5</sup> / <sub>8</sub> "W x 12"D	2', 3', 4', 5', 6', 8', 10', 12'
10"	14"W x 16"D	2', 3', 4', 5', 6', 8', 10', 12'
12"	16"W x 20"D	2', 3', 4', 5', 6', 8', 10', 12'
15"	20"W x 24"D	2', 3', 4', 5', 6', 8', 10', 12'
18"	24"W x 28"D	2', 3', 4', 5', 6', 8', 10', 12'
24"	31"W x 39"D	3', 4', 5', 6', 8', 10'

Box width reflects the coupler side panel of structure. Larger CMP structures also available. Call for details on custom sizes and pricing.

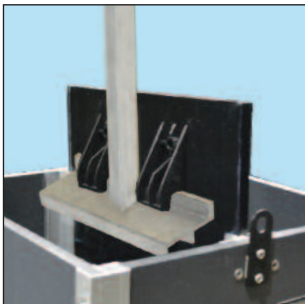

Rugged injection molded stoplogs used in structures with 4", 6", 8", 10", and 12" pipe sizes.



PVC stoplogs with stainless steel lifting hooks used in structures with 15", 18", and 24" pipe sizes.

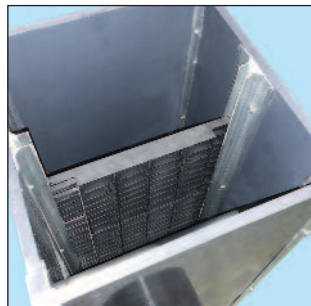

Bird's-eye view of the stoplogs in structure tracks.



Flexible rubber connectors with heavy-duty stainless steel clamps.

Handle (included) is used to install and remove stoplogs.

## MANUAL INLINE WATER LEVEL CONTROL STRUCTURE™

- Constructed of rugged 1/2" PVC with lockable plastic lid.
- Stainless steel screws and custom anodized aluminum corner extrusions used for strength and durability\*.
- Flexible couplers allow PVC, plastic pipe, or other materials to be easily attached. *(Please specify type of pipe when ordering.)*
- Stoplogs made of PVC in 5" and 7" heights for adjustability. (Maintenance recommended: Remove stoplogs and grease seal with Ultra Lube [included]. Ensure there is no debris in the tracks or along the bottom of the structure. Replace stoplogs after greasing, ensuring bottom stoplog is installed first.)
- To minimize seepage, align stoplogs against one side of stoplog track.
- Stoplogs must remain in track during structure installation.
- Structures are intended for gravity flow only; some seepage may occur.
- 5-year warranty on all standard structures.

\*For water that is caustic, acid, corrosive, salt, or pH below 5 pH or above 9 pH, please notify us of your requirements to ensure structures are built with compatible hardware. For these applications, Agri Drain recommends stainless steel.

## STOPLOG RETAINER

- For use with Agri Drain In-line Water Level Control Structures™ to hold extra stoplogs up & out of the way.
- Stainless steel retainer hooks to lowest stoplog that you want to hold up within your structure.
- 10' of 3/16" nylon rope (included) attaches to the retainer and secures to the inner brace bar near the top of the structure.
- Narrow retainer (item# 701300) is for use with In-line structures with 4", 6", 8", 10", & 12" pipe sizes.
- Wide retainer (item# 701299) is for use with In-line structures with 15", 18", & 24" pipe sizes.

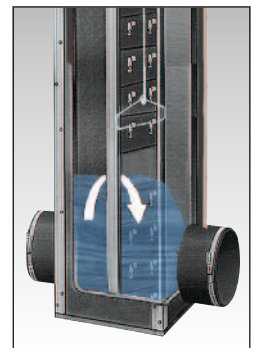

Call Agri Drain at 1-800-232-4742

# STRUCTURES, VALVES, & GATES

## Agri Drain Smart CORPORATION

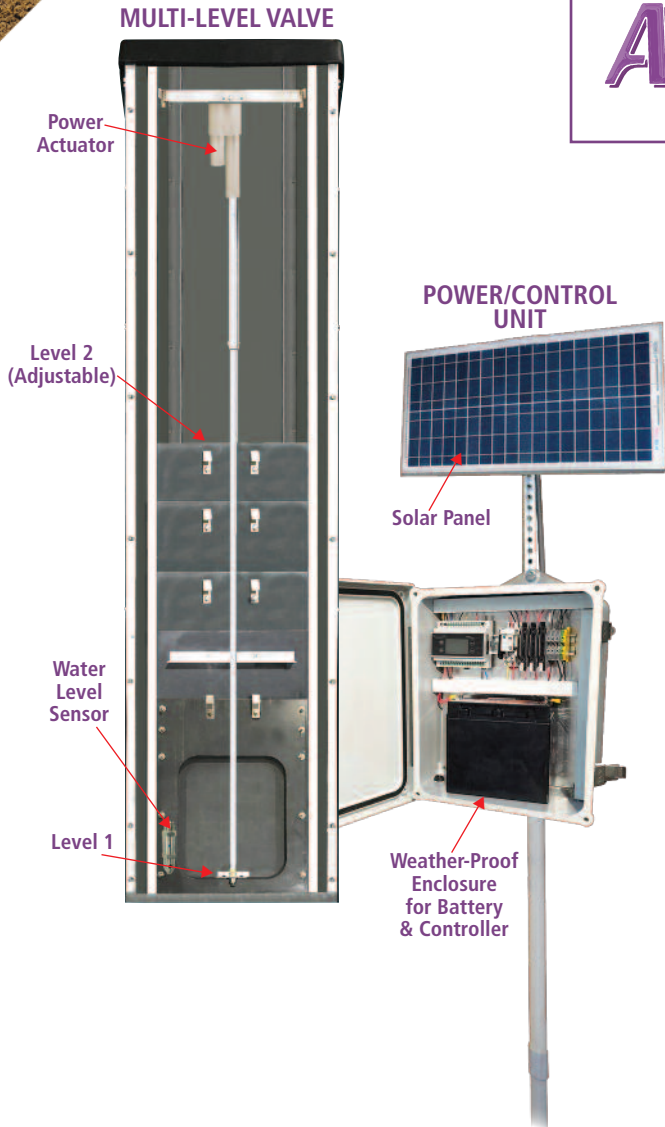

### MULTI-LEVEL AUTOMATED REMOTE-CONTROL VALVE

Add multi-level, automated, remote-control capabilities to Agri Drain's Inline Water Level Control Structures™ in pipe sizes up to 15"-diameter.

#### Features:

- PVC Slide Gate Valve.
- Power actuator to open and close the slide gate valve.
- Water level sensor to monitor water level in the structure.
- Solar panel and battery to provide power to the system.
- Programmable controller with cellular/cloud-based communications.
- Weather-proof enclosure.

#### Specs:

- Same specs as the Inline structure.
- Available for pipe sizes up to 15"-diameter.
- Components slide into tracks of an Inline structure.

#### Smart Drainage Site Options:

- Monitor and manage your system remotely.
- Open/close valve on demand or automatically based on desired set-points and a year-round schedule.
- Operates in drainage water management or irrigation mode.
- 365 water level set-point options.
- Four water level timers.
- Four drain duration timers.

#### USER DASHBOARD & SET POINTS

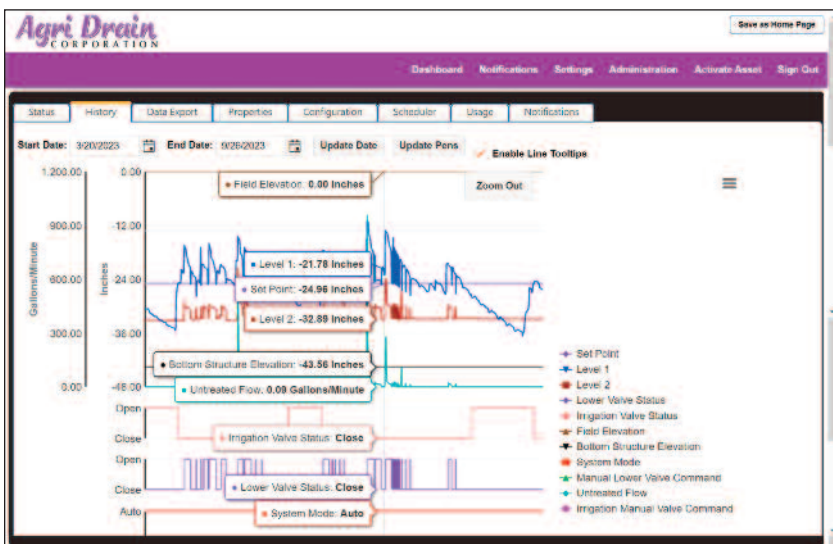

#### Dashboard Display Options:

- Water Level
- Flow Measurements
- Battery Condition
- Current Valve Position
- Historical Set-Points

US Patent No. 6,715,508 B2  
US Patent No. 6,786,234 B2  
Canadian Patent No. 2,403,456  
Canadian Patent No. 2,466,976

# Drainage System<sup>®</sup>

## 2 & 3 LEVEL AUTOMATED VALVE

Add 2 & 3 level, automated, local-control capabilities to Agri Drain's Inline Water Level Control Structures™ in pipe sizes up to 15"-diameter.

### Features:

- Choice of one or two PVC Slide Gate Valve(s).
- Choice of one or two power actuator(s) to open and close the slide gate valve(s) in either a 2 level or 3 level structure.
- Solar panel and battery to provide power to the system.
- Locally-programmable controller.
- Weather-proof enclosure.

### Specs:

- Same specs as the Inline structure.
- Available for pipe sizes up to 15"-diameter.
- Components slide into tracks of an Inline structure.

### Locally Programmable Options:

- Monitor and manage your system locally, on-site.
- Locally programmable controller allows for manual and automatic modes of operation.
- Manual mode consists of setting the valve to open or close from the controller's front panel.
- Automatic mode allows the user to configure a desired schedule and duration for opening and closing the valve.

## V-NOTCH WEIRS

- V-Notch Weirs are available to fit in 4" through 24" pipe size water level control structures.
- Constructed of rugged PVC with stainless steel plate.
- V-notch plate is cut at a 45 degree angle allowing accurate measurement and calculation of flow rates.



### POWER/CONTROL UNIT

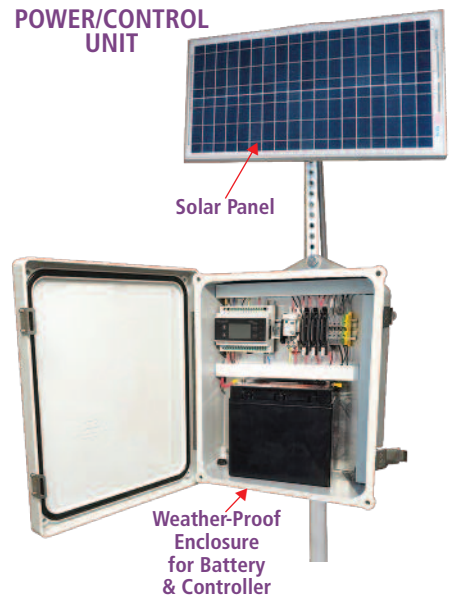

### 2 LEVEL VALVE



### 3 LEVEL VALVE



V-NOTCH WEIRS		
Size	Item#	Description
7 <sup>3</sup> / <sub>4</sub> " W x 12" H	701131	4"/6" V-Notch Weir
11 <sup>1</sup> / <sub>4</sub> " W x 12" H	701132	8" V-Notch Weir
13 <sup>3</sup> / <sub>4</sub> " W x 12" H	701133	10" V-Notch Weir
15 <sup>3</sup> / <sub>4</sub> " W x 12" H	701134	12" V-Notch Weir
19 <sup>3</sup> / <sub>4</sub> " W x 12" H	701135	15" V-Notch Weir
23 <sup>3</sup> / <sub>4</sub> " W x 12" H	701136	18" V-Notch Weir
30 <sup>3</sup> / <sub>4</sub> " W x 12" H	701409	24" V-Notch Weir

Item# 701131 fits Inline Structures only. For Inlet Structures with 4" or 6" pipe size, use item# 701132.

Call Agri Drain at 1-800-232-4742

# STRUCTURES, VALVES, & GATES

## WATER GATE VALVES

Conserve water. • Increase yields. • Reduce nutrient loss.

Enjoy the agricultural and environmental benefits of **VARIABLE RATE DRAINAGE®** with Agri Drain's Water Gate.

The Water Gate is an infinitely variable, float-activated head pressure valve that manages up to 12"-diameter drain tile, available in either a 6" or 12" lift. (Lift refers to the increase in water elevation the valve can maintain between the downstream and upstream side of the valve.)

The Water Gate operates in either free-flow or managed-flow mode. The managed-flow mode is activated by backing water up into the valve. This is accomplished by installing an Inline Water Level Control Structure (WLCS) in the tile main at the lowest point of the drainage system that you wish to control.

**For Water Gates with 6" lift**, after installing the WLCS, check the elevation of the inside bottom of the structure then locate the point at which flow line of the tile is 6" higher in elevation. This is where the first Water Gate will be installed. When installing a series of Water Gates, continue to locate them at 6" elevation intervals. The minimum stoplog elevation at the WLCS must be 18" to obtain 6" of lift at the Water Gate valve. Additional stoplogs can be added to raise upstream water throughout the system.

**For Water Gates with 12" lift**, after installing the WLCS, check the elevation of the inside bottom of the structure, then locate the point at which flow line of the tile is 12" higher in elevation. This is where the first Water Gate will be installed. When installing a series of Water Gates, continue to locate them at 12" elevation intervals. The minimum stoplog elevation at the WLCS must be 24" to obtain 12" of lift at the Water Gate valve. Additional stoplogs can be added to raise upstream water throughout the system.

- Manage up to 12"-diameter subsurface drain tile.
- Available in either a 6" or 12" lift. (Specify lift when ordering.)
- Completely buried to allow for convenient field operations.
- Installation using flexible couplers on the upstream and downstream sides is recommended.
- Valve is not pressure rated.
- Valve is intended for gravity flow: low pressure and some seepage may occur.\*

\*To minimize seepage, we recommend installing 20' of non-perforated pipe on the upstream side of the Water Gate, or using an Anti-Seep Collar below the Water Gate.

WATER GATE VALVES		
Size	Lift	Item#
8" Valve	6" Lift	WGATEVALVE08_06
8" Valve	12" Lift	WGATEVALVE
10" Valve	6" Lift	WGATEVALVE10_06
10" Valve	12" Lift	WGATEVALVE10
12" Valve	6" Lift	WGATEVALVE12_06

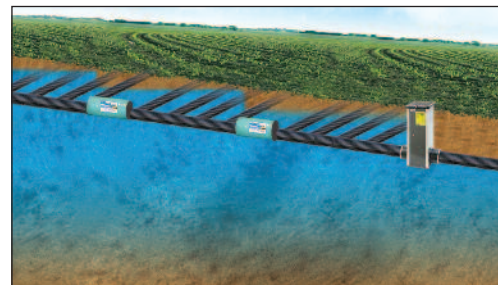

Side view of how Inline Water Level Control Structure™ and Water Gates "stair-step" water up through the soil profile.

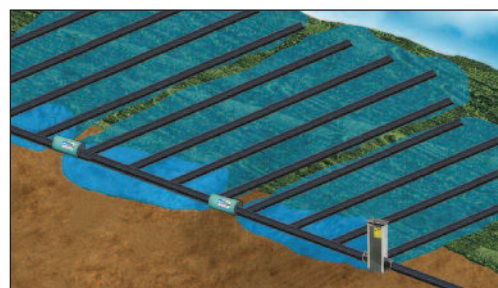

Top view showing the zones of influence that each device manages.

## The WATER GATE



Illustration shows 12" lift. Also available in 6" lift.



U.S. Patent No. 7,942,606 B2  
Canadian Patent No. 2,675,810



# CHECK VALVES

*Effectively prevent backflow in drainage lines.*

- Must provide a stable base, and installation using flexible couplers is recommended.
- Horizontal installation in drainage systems helps keep basements from flooding.
- Eliminates backup in field tile when creeks rise.
- 6" SDR35 PVC clean out with threaded plug allows easy maintenance and inspection.
- Fits SCH40 PVC pipe.



CHECK VALVES		
Size	Item#	Description
3" Valve	CV03	3" Check Valve with Clean Out
4" Valve	CV04	4" Check Valve with Clean Out

Quantity discounts available.

6" – 12" valves are constructed of rugged SDR35 PVC.

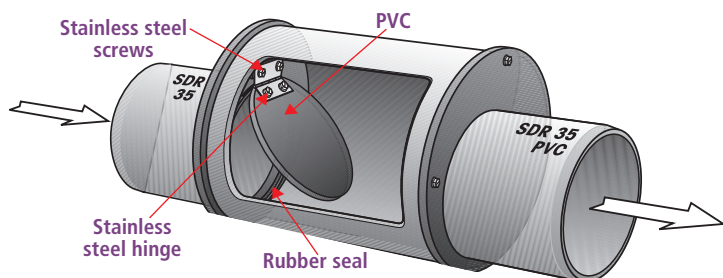

15" – 18" valves are constructed of rugged 1/2"-thick PVC, with custom anodized aluminum corner extrusions, with SDR35 PVC stubs.

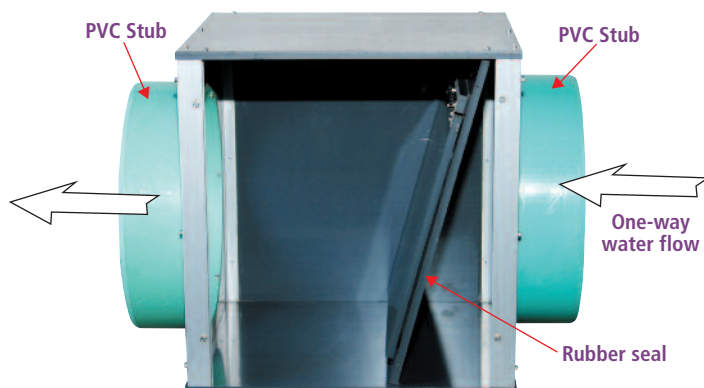

# AGRI DRAIN CHECK VALVES

*Agri Drain Check Valves offer effective prevention of backflow in drainage lines.*

- Must provide a stable base, and installation using flexible couplers is recommended.
- Available with a 6" SDR35 PVC clean out with a threaded plug to allow easy maintenance and inspection.
- Offers full flow for drainage.
- Valve is not pressure rated.
- Valve is intended for gravity flow: Low pressure and some seepage will occur.

AGRI DRAIN CHECK VALVES		
Size	Item#	Description
6"	CV06	6" Check Valve
6"	CV06C	6" Check Valve with Clean Out
8"	CV08	8" Check Valve
8"	CV08C	8" Check Valve with Clean Out
10"	CV10	10" Check Valve
10"	CV10C	10" Check Valve with Clean Out
12"	CV12	12" Check Valve
12"	CV12C	12" Check Valve with Clean Out
15"	CV15	15" Check Valve
15"	CV15C	15" Check Valve with Clean Out
18"	CV18	18" Check Valve
18"	CV18C	18" Check Valve with Clean Out

Call Agri Drain at 1-800-232-4742

# STRUCTURES, VALVES, & GATES

## VALTERRA GATE VALVES

*Inexpensive valve for industrial, agricultural, and commercial markets.*

- Must provide a stable base.
- Quick shutoff in low pressure or vacuum lines.
- Well suited as a drain valve to tanks.
- Attaches to SCH40 PVC pipe.
- Trouble-free simplicity.
- 100% water tested at factory.
- Cannot be submersed; not potable water rated.

**⚠ WARNING: Cancer and Reproductive—Harm** [www.P65Warnings.ca.gov](http://www.P65Warnings.ca.gov)

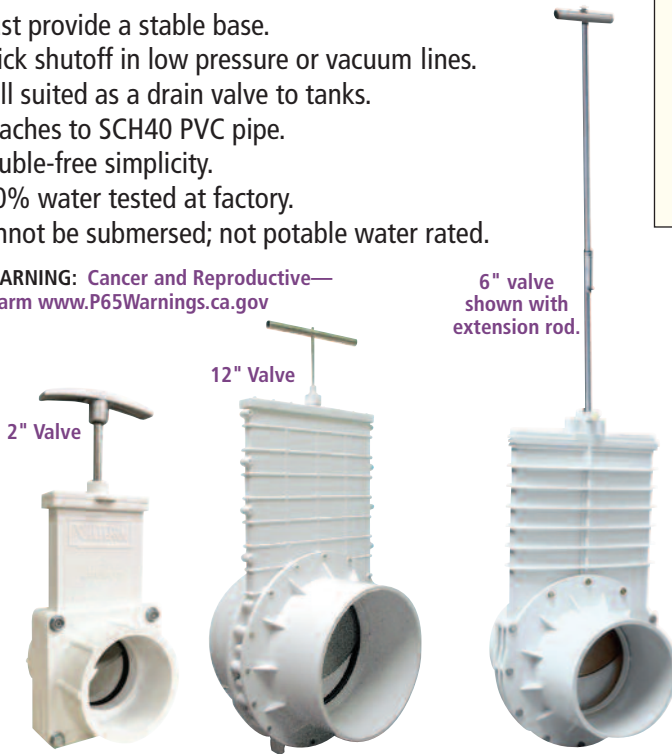

VALTERRA SLIDE GATE VALVES			
Size	Item#	Height with Handle Closed	Height with Handle Extended
1 1/2"	VV01.5	6.5"	8.625"
2"	VV02	7.5"	10.25"
3"	VV03	9.25"	13"
4"	VV04	13.25"	18"
6"	VV06	22.75"	31.125"
8"	VV08	22.75"	31.125"
10"	VV10-40	35"	48.5"
12"	VV12-40	35"	48.5"

EXTENSION ROD FOR 1 1/2"–4" VALVE	
Rod Height	Item#
12"	TX12T
24"	TX24T
36"	TX36T
48"	TX48T

EXTENSION ROD FOR 6"–8" VALVE	
Rod Height	Item#
12"	X8-12
36"	X8-36
72" (two 36" pieces)	X8-72

EXTENSION ROD FOR 10"–12" VALVE	
Rod Height	Item#
36"	X12-36

## SLIDE GATE VALVES

*Agri Drain Slide Gate Valves allow you to shut off the flow of water in your tile line for effective water control and easy maintenance.*

- Must provide a stable base, and installation using flexible couplers is recommended.
- Valve allows easy shut off of underground pipes.
- All parts are made out of super tough high-density PVC and high-quality stainless steel for maximum durability and corrosion resistance.
- Stubs are 4" long, SDR35 PVC male.
- Extension handle (not included) is used to open and close the valve at varying depths.
- This product is not for use in lagoon or non-gravity flow applications.
- Valves are not pressure rated.
- Valves are intended for gravity flow only; low pressure and some seepage may occur.
- This product carries a 1-year warranty. Any modification to product will void the warranty.

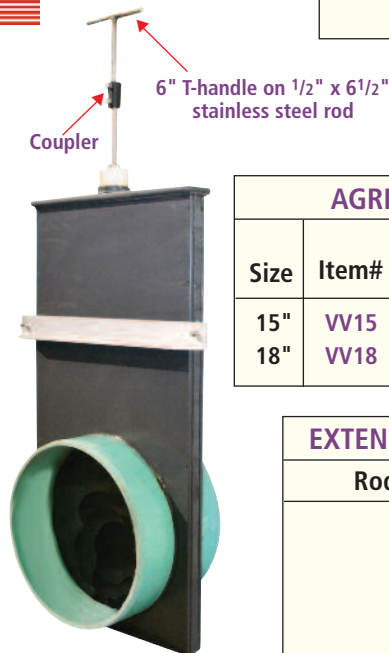

AGRI DRAIN SLIDE GATE VALVES			
Size	Item#	Height with Handle Closed	Height with Handle Extended
15"	VV15	52"	67"
18"	VV18	55"	74"

EXTENSION HANDLE FOR 15" - 18" VALVE	
Rod Height	Item#
24"	VVEH2
36"	VVEH3
48"	VVEH4
60"	VVEH5
72"	VVEH6
84"	VVEH7
96"	VVEH8

*VVEH5 and larger come in two pieces that bolt together in middle (bolt included).*

# STANDARD FLAP GATES

*Keep damaging water out of drainage systems.*

## FLAP GATES, STAINLESS STEEL

- Designed for use on PVC, CMP, and corrugated plastic tubing.
- Stainless Steel Flap Gates are not powder coated.
- Constructed of 304 stainless steel. Great for use where water is caustic, acid, corrosive, salt, or pH below 5 pH or above 9 pH.
- Flap Gates do not have a gasket and are not watertight.
- Flap should sit flush against the pipe, not the band, to ensure optimal performance.
- Please specify type of pipe when ordering.

**Extended Life!**

STAINLESS STEEL		
Size	PVC, CMP, Etc. Item#	Corrugated Plastic Tubing Item#
4"	FG04SS*	FG04SS
6"	FG06SS*	FG06SS
8"	FG08SS	FG08PSS
10"	FG10SS	FG10PSS
12"	FG12SS	FG12PSS
15"	FG15SS	FG15PSS
18"	FG18SS	FG18PSS

Item #FG04SS and #FG06SS can be used for PVC, CMP, and corrugated plastic tubing. Call for larger sizes in stainless steel.



## FLAP GATES, MILD STEEL

- Designed for use on PVC, CMP, and corrugated plastic tubing.
- Flaps for mild steel Flap Gates are galvanized up to FG15 size. Flaps for FG15P and larger are powder coated. Mild steel attachment brackets have a durable powder coat finish.
- Flap Gates do not have a gasket and are not watertight.
- Flap should sit flush against the pipe, not the band, to ensure optimal performance.
- Please specify type of pipe when ordering.

Standard flap gates fit all PVC, CMP, and other similar types of pipe.

MILD STEEL		
Size	PVC, CMP, Etc. Item#	Corrugated Plastic Tubing Item#
4"	FG04*	FG04
6"	FG06*	FG06
8"	FG08	FG08P
10"	FG10	FG10P
12"	FG12	FG12P
15"	FG15	FG15P
18"	FG18	FG18P
21"	FG21	N/A
24"	FG24	FG24P
30"	FG30	FG30P
36"	FG36	FG36P
42"	N/A	FG42P

\*4" and 6" not available with a wide band. Item #FG04 and #FG06 can be used for PVC, CMP, and corrugated plastic tubing.



This special flap gate is designed with an extra-wide band that catches several corrugations on corrugated plastic tubing.

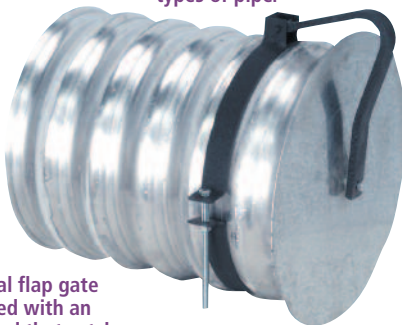

HEAVY DUTY FLAP GATES	
Size	PVC, CMP, Etc. Item#
6"	FG06HD
8"	FG08HD
10"	FG10HD
12"	FG12HD
15"	FG15HD
18"	FG18HD
21"	FG21HD
24"	FG24HD
30"	FG30HD
36"	FG36HD

## HEAVY DUTY FLAP GATES

*Dual-hinged with stainless steel bolts for better performance.*

- Designed for use on PVC and CMP.
- Not designed for use on corrugated plastic tubing.
- Constructed of rugged  $\frac{3}{16}$ " steel material with a durable powder coat finish.
- Flap Gates do not have a gasket and are not watertight.
- Flap should sit flush against the band, not the pipe, to ensure optimal performance.

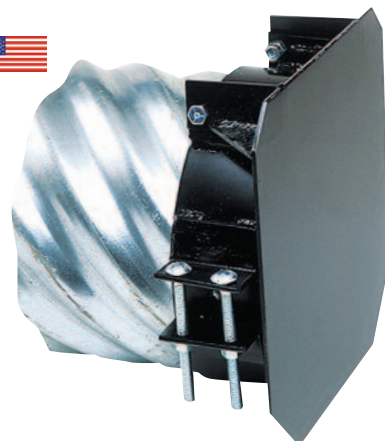

**Call Agri Drain at 1-800-232-4742**

# PIPE & ACCESSORIES

## CORRUGATED PLASTIC PIPE & FITTINGS

### FLEXIBLE DUAL-WALL

- Installs up to 60% faster than traditional dual-wall.
- Feeds directly from a stringer to a plow boot, vastly decreasing installation speed and improving safety.
- Available in 8", 12" and 15".



### CORRUGATED METAL PIPE & FITTINGS

- Wide variety of corrugations, diameters, and lengths.
- Large selection of accessories, fittings, and bands.
- Galvanized pipe in 6" through 36" (larger sizes available).
- Aluminum pipe available in 6" through 10" (larger sizes available).



### TILE CUTTERS

*Cut through corrugated plastic pipe with ease.*

- For cutting through 6"-12" corrugated plastic pipe.
- Features an 11 gauge, stainless steel blade.
- Cushioned, rubber handles for greater comfort.

**TILECUTTER06,**  
6"-8" Tile Cutter  
**TILECUTTER12,**  
10"-12" Tile Cutter



### SINGLE-WALL & DUAL-WALL

- Single-wall, dual-wall, perforated, non-perforated, sticks, mini rolls, and maxi coils.
- Available in 3" through 36", larger sizes available.



### 24" HEAVY DUTY LID

- Includes places for screws to be used to anchor lid to pipe.
- Slots on bottom side allow concrete to be used to increase weight of lid.
- Load rated up to 2,400 lbs. (driving over not recommended).

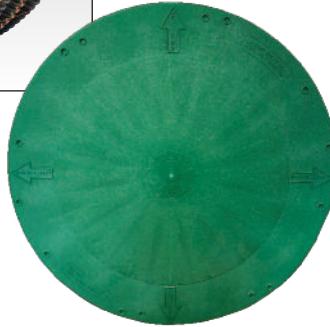

**AD24-RISL-FLAT,** 24" Heavy Duty Lid

### PIPE STRAPS

*Ideal for use on steep grades, high fills, and unstable soil conditions.*

- Low stretch, easy to install. Fits up to 24" pipe size.
- One set includes: two 10'-long straps with D-rings and two 3" loops with D-rings. Straps and loops are made of 3,500# polyester webbing.
- This product carries a 1-year warranty.



**PTPS,** Pipe Strap Set

### EZTEE

- 4" EZTee for use on corrugated plastic pipe.
- Rugged hinge allows tee to lay flat; easily stack 10/box.
- Internal tabs lock into corrugated plastic pipe for secure connection.
- Complies with ASTM F 405-13 & AASHTO M 252-09 standards.
- Stackable design saves space! Available individually or 10 per box.

**EZT04,** 4" EZTee

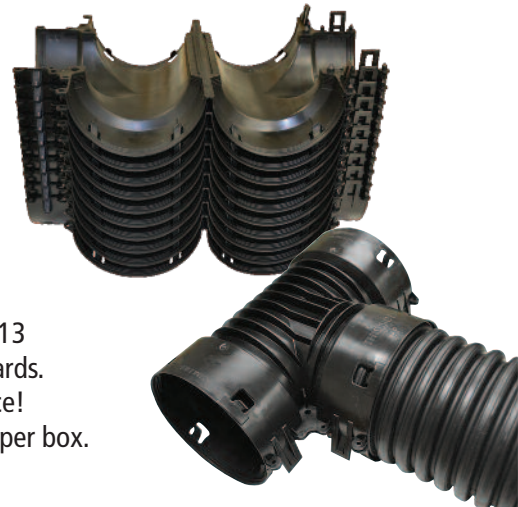



## AMAZING TILE TAPE

*Tile Tape works in cold and wet weather.*

- Makes watertight junctions and connections.
- Provides super stretchability.
- Made out of PVC.
- Large roll available in 2" wide or 4" wide x 108' long.
- Custom printed labels available. Call for details on setup charge and minimum quantity.

TILE TAPE		
Roll Size	Item#	Description
2" x 108'	BT02ADC	Single Roll
2" x 108'	BT02P	6-Pack
2" x 108'	BT02CA	24-Roll Case <b>Best Value!</b>
4" x 108'	BT04ADC	Single Roll
4" x 108'	BT04CA	12-Roll Case <b>Best Value!</b>
4" Handle	4THANDLE	4" Tape Handle



**WARNING:** This product can expose you to chemicals including toluene, which is known to the State of California to cause cancer or reproductive harm. Go to [www.P65Warnings.ca.gov](http://www.P65Warnings.ca.gov)

## ANTI-SEEP COLLARS

*Keep your pipe from being washed out.*

- The Anti-Seep Collar works with any smooth-wall pipe or corrugated plastic tubing.
- 1/16" Gum rubber with wood frame.
- Tan floating stock has superior resilience, elongation, and tear strength.
- Resistant to water, most salts, mild acids, and many other chemicals.

ANTI-SEEP COLLARS		
Size	Item#	Recommended Pipe Sizes
2' x 2'	ASC02	3"
3' x 3'	ASC03	4", 5", 6", 8", 10", 12"
4' x 4'	ASC04	15", 18", 24"
5' x 5'	ASC05	30", 36"
6' x 6'	ASC06	42", 48", 60"

*Installed in three easy steps:*

1. Unroll Anti-Seep and align boards to form a square. Attach metal brackets to corner of boards with screws provided. Attach rubber to frame with nails provided.
2. Cut a round hole\* in rubber 33% smaller than your pipe size.
3. Insert pipe through hole in rubber.

\*YOU MUST CUT A ROUND HOLE. Cutting an "X" or slit will cause gum rubber to rip.



Call Agri Drain at 1-800-232-4742

# PIPE & ACCESSORIES

## PIPE CONNECTORS

*Other sizes and types available—call for details.*

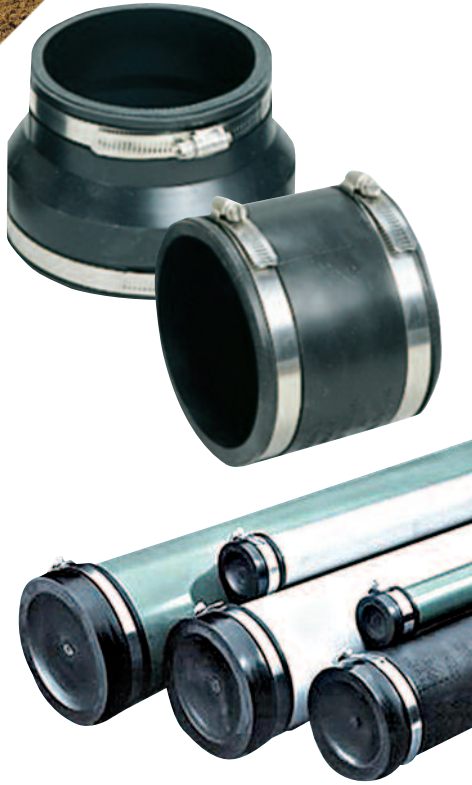

### COUPLINGS

Size	Item#	Description	Size	Item#	Description
1 1/4" x 1 1/4"	FCPP01.25X01.25	PVC to PVC	4" x 4"	FCCP04X04	Clay to PVC
1 1/4" x 1 1/2"	FCPP01.25X01.5	PVC to PVC	6" x 4"	FCCP06X04	Clay to PVC
1 1/2" x 1 1/2"	FCPP01.5X01.5	PVC to PVC	6" x 6"	FCCP06X06	Clay to PVC
1 1/2" x 2"	FCPP01.5X02	PVC to PVC	8" x 6"	FCCP08X06	Clay to PVC
2" x 2"	FCPP02X02	PVC to PVC	8" x 8"	FCCP08X08	Clay to PVC
2" x 3"	FCPP02X03	PVC to PVC	10" x 10"	FCCP10X10	Clay to PVC
3" x 3"	FCPP03X03	PVC to PVC	12" x 12"	FCCP12X12	Clay to PVC
2" x 4"	FCPP02X04	PVC to PVC	15" x 15"	FCCP15X15	Clay to PVC
3" x 4"	FCPP03X04	PVC to PVC	18" x 18"	FCCP18X18	Clay to PVC
4" x 4"	FCPP04X04	PVC to PVC	4" x 4"	FCCC04X04	Clay to Clay
6" x 4"	FCPP06X04	PVC to PVC	6" x 4"	FCCC06X04	Clay to Clay
6" x 6"	FCPP06X06	PVC to PVC	6" x 6"	FCCC06X06	Clay to Clay
8" x 6"	FCPP08X06	PVC to PVC	8" x 8"	FCCC08X08	Clay to Clay
8" x 8"	FCPP08X08	PVC to PVC	10" x 10"	FCCC10X10	Clay to Clay
10" x 8"	FCPP10X08	PVC to PVC	12" x 12"	FCCC12X12	Clay to Clay
10" x 10"	FCPP10X10	PVC to PVC	15" x 15"	FCCC15X15	Clay to Clay
12" x 12"	FCPP12X12	PVC to PVC	18" x 18"	FCCC18X18	Clay to Clay
15" x 15"	FCPP15X15	PVC to PVC	24" x 24"	FCCC24X24	Clay to Clay
18" x 18"	FCPP18X18	PVC to PVC	4" x 4"	FCCP04X04	Fiber to PVC
21" x 21"	FCPP21X21	PVC to PVC	6" x 6"	FCCP06X06	Fiber to PVC
24" x 24"	FCPP24X24	PVC to PVC	8" x 8"	FCCP08X08	Fiber to PVC

### Supported Connections

- **PVC-PVC Couplings:** PVC or CMP to PVC or CMP.
- **Clay-PVC Couplings:** clay or corrugated plastic pipe to PVC or CMP.
- **Clay-Clay Couplings:** clay or corrugated plastic pipe to clay or corrugated plastic pipe.
- **Fiber-PVC Couplings:** fiber to PVC or CMP.

### TEES & WYES

Size	Item#	Description	Size	Item#	Description
4"	FEDFW-4TC	4" Flex Saddle Tee	4"	FEDFW-4WYE	4" Flex Saddle Wye
6"	FEDFW-6TC	6" Flex Saddle Tee	6"	FEDFW-6WYE	6" Flex Saddle Wye

### CAPS

Size	Item#	Description	Size	Item#	Description
1 1/2"	FCAP01.5	Flexible Sewer Cap	8"	FCAP08	Flexible Sewer Cap
2"	FCAP02	Flexible Sewer Cap	10"	FCAP10	Flexible Sewer Cap
3"	FCAP03	Flexible Sewer Cap	4"	PCPCXQC475	Flexible Tile Cap
4"	FCAP04	Flexible Sewer Cap	6"	PCPCXQC700	Flexible Tile Cap
6"	FCAP06	Flexible Sewer Cap	8"	PCPCXQC900	Flexible Tile Cap



## EXTERNAL GUARDS

*Agri Drain's External Guards provide superior outlet protection.*

- Available to fit 4", 6", or 8" pipe.
- 4" and 6" External Guards are Iowa DOT approved.
- EG06 is designed for use on CMP; not designed for use on corrugated plastic tubing.
- Galvanized expanded metal is 1/2" – Standard #13.

### EXTERNAL GUARDS

Size	Item#	Description
4"	EG04	4" Guard for PVC, Corrugated Plastic
6"	EG06	6" Guard for CMP
8"	EG08	8" Guard for PVC, CMP
8"	EG08P	8" Guard for Corrugated Plastic

All bars are MIG welded on both sides.

# RAT GUARDS™

Avoid irritating and costly plugged drainage systems with stainless steel, zinc dichromate-plated mild steel, and zinc dichromate-plated band-type Rat Guards.



**Extended Life!**

## RAT GUARDS, STAINLESS STEEL

- 304 Stainless steel material and hardware resists rust and corrosion and provides extended life.
- 4" and 6" Stainless Steel Rat Guards are Iowa DOT approved.
- Easy to install. Position far enough in the pipe to allow it to swivel up and let debris pass without exposing the Rat Guard beyond the pipe.
- 18" & 24" Rat Guard is held in place with a steel rod (included) which extends through the frame and then through the pipe. Rod extends approximately 1" on either side of frame.

STAINLESS STEEL			
Size	Item#	Price Break Quantities	Case Quantity
4"	RGSS04	1-99, 100+	100 per case
6"	RGSS06	1-99, 100+	100 per case
8"	RGSS08	1-49, 50+	50 per case
10"	RGSS10	1-29, 30+	30 per case
12"	RGSS12	1-19, 20+	20 per case
15"	RGSS15	1-9, 10+	10 per case
18"	RGSS18		
24"	RGSS24		

## RAT GUARDS, MILD STEEL

- Zinc dichromate plating resists corrosion.
- Easy to install. Position far enough in the pipe to allow it to swivel up and let debris pass without exposing the Rat Guard beyond the pipe.
- 18" through 60" Rat Guard is held in place with a steel rod (included) which extends through the frame and then through the pipe. Rod extends approximately 1" on either side of frame.

MILD STEEL			
Size	Item#	Price Break Quantities	Case Quantity
4"	RG04	1-9, 10-99, 100+	100 per case
6"	RG06	1-9, 10-99, 100+	100 per case
8"	RG08	1-9, 10-49, 50+	50 per case
10"	RG10	1-9, 10-29, 30+	30 per case
12"	RG12	1-9, 10-19, 20+	20 per case
15"	RG15	1-9, 10+	10 per case
18"	RG18		
21"	RG21		
24"	RG24		
30"	RG30		
36"	RG36		
42"	RG42		
48"	RG48		
54"	RG54		
60"	RG60		

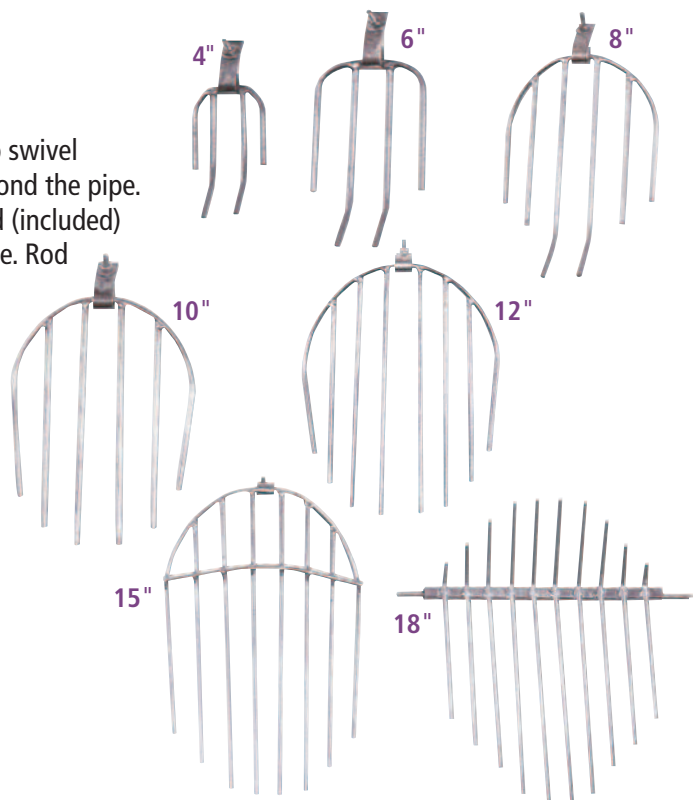

## RAT GUARDS, BAND-TYPE

- Zinc dichromate plating resists corrosion.
- Easy to install. No drilling required.
- Designed to fit 6" through 24" CMP, PVC, and other similar types of pipe.
- Not designed for use on corrugated plastic tubing.

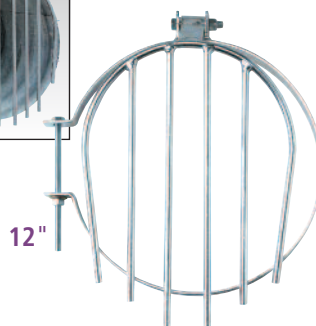

BAND-TYPE	
Size	PVC, CMP, Etc. Item#
6"	RG06BT
8"	RG08BT
10"	RG10BT
12"	RG12BT
15"	RG15BT
18"	RG18BT
24"	RG24BT

Call Agri Drain at 1-800-232-4742

# SURFACE INLETS

## STANDARD BAR GUARDS

*Eliminate plugged inlets with Bar Guards.*

- Unique design helps keep intakes from plugging with crop residue or any other type of debris.
- The Bar Guard may also protect pond tubes from rodent entry.
- Constructed of 1/4" steel rod on 4" through 15", 5/16" steel rod on 18" through 36", and 3/8" steel rod on 42" and 48".
- Available in yellow or black powder coated finish.

STANDARD				
Size	Item# Yellow	Item# Black	Price Break Quantity	Case Quantity
4"	BG04	BG04B	1-8, 9+	9 per case
5"	BG05	BG05B	1-8, 9+	9 per case
6"	BG06	BG06B	1-8, 9+	9 per case
8"	BG08	BG08B	1-5, 6+	6 per case
8"H	BG08H*	BG08HB*	1-5, 6+	6 per case
10"	BG10	BG10B		
10"H	BG10H*	BG10HB*		
12"	BG12	BG12B		
15"-12"H	BG15/12H*	BG15/12HB*		
18"	BG18	BG18B		
21"	BG21	BG21B		
24"	BG24	BG24B	(2 pieces)	
30"	BG30	BG30B	(2 pieces)	
36"	BG36	BG36B	(4 pieces)	
42"	BG42	BG42B	(4 pieces)	
48"	BG48	BG48B	(4 pieces)	



HEAVY DUTY				
Size	Item# Yellow	Item# Black	Price Break Quantity	Case Quantity
4"	BG04HDY	BG04HD	1-8, 9+	9 per case
6"	BG06HDY	BG06HD	1-4, 5+	5 per case
8"	BG08HDY	BG08HD	1-5, 6+	6 per case
8"H	BG08HDHY*	BG08HDH*	1-4, 5+	5 per case
10"	BG10HDY	BG10HD		
10"H	BG10HDHY*	BG10HDH*		
12"	BG12HDY	BG12HD		
15"-12"H	BG15HD/12HDHY*	BG15HD/12HDH*		
18"	BG18HDY	BG18HD		
24"	BG24HDY	BG24HD		
30"	BG30HDY	BG30HD	(3 pieces)	
36"	BG36HDY	BG36HD	(4 pieces)	
48"	BG48HDY	BG48HD	(2 pieces)	

## HEAVY DUTY BAR GUARDS

*Keeps out the big chunks.*

- Provides maximum flow rates while allowing small debris to pass.
- An excellent choice in any situation where a low-profile, high-capacity intake is required.
- Constructed of 1/4" steel rod on 4" and 6", 5/16" steel rod on 8", 3/8" steel rod on 10", and 1/2" steel rod on 12" through 36".
- Available in yellow or black powder coated finish.

\*Special-sized Bar Guards to fit Hickenbottom Intakes (See page 23.)



## ANTI-VORTEX PLATE & HARDWARE

Size	Item#
4"	701598
5"	701599
6"	701600
8"	701601
8"H	701602
10"	701603
10"H	701604
12"	701605
15"-12"H	701606
18"	701607
21"	701608
24"	701609
30"	701610
36"	701611

Anti-Vortex Plates designed to fit Standard Bar Guards.

# ANTI-VORTEX PLATES & HARDWARE

- Installing an Anti-Vortex Bar Guard on your vertical intake pipe reduces swirling flow, decreases entrained air into pipe, and increases discharge efficiency.
- Galvanized anti-vortex plate runs through the center of the Standard Bar Guard.

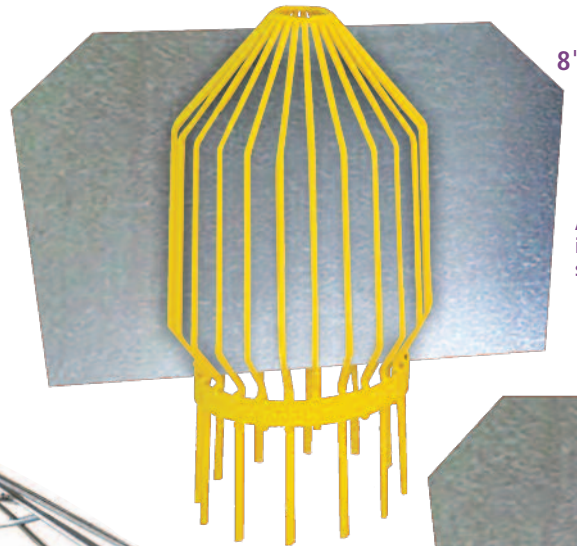

8"

Anti-vortex plate shown installed in Standard Bar Guard. Bar Guard sold separately.

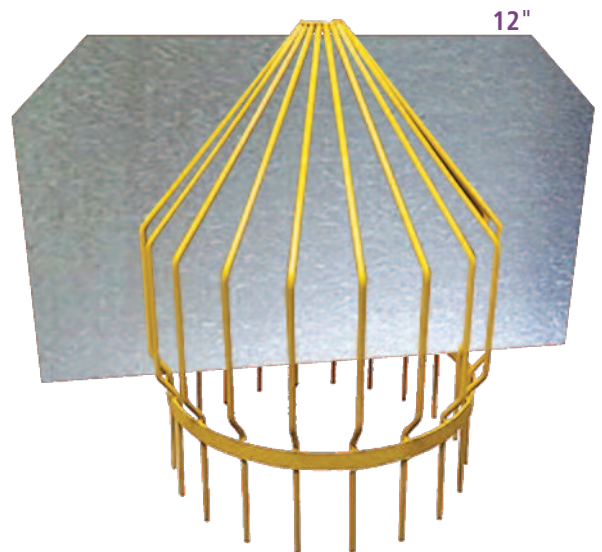

12"



30"



8"

## TRASH RACK FOR CANOPY INLET

- Trash Racks are designed to help prevent floating and submerged debris from entering your drainage system while maintaining water flow.
- Available in a wide range of sizes and designs, fabricated from galvanized or powder-coated mild or stainless steel.
- Fit a variety of pipe types including concrete, metal, and plastic pipe.
- Bolts securely on the outside of your pipe (hardware included).
- Custom Trash Racks can be fabricated to meet project-specific requirements.
- Call for your free, no-obligation quote today!

Call Agri Drain at 1-800-232-4742

# SURFACE INLETS

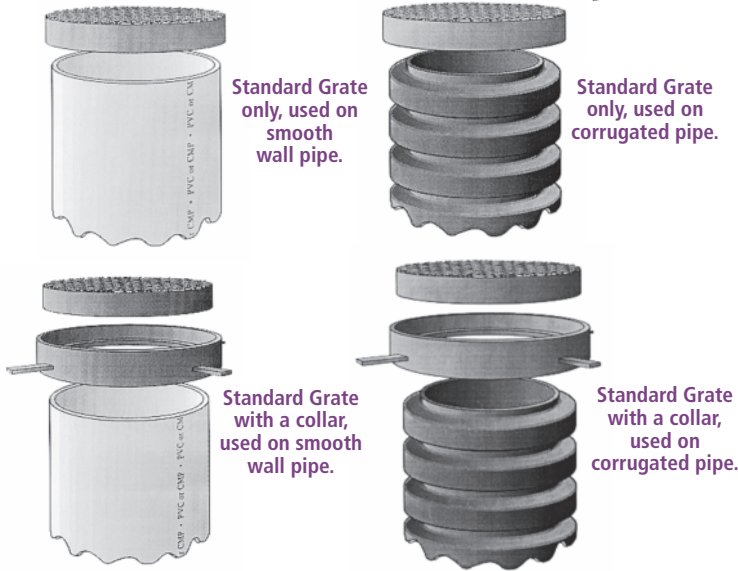

## STANDARD GRATES

*Standard grates are constructed of heavy steel and durable expanded metal.*

- Standard Grates are not load rated.
- Low profile; allows mowers to pass over.
- Durable powder coat finish for years of service.
- Grates are oversized to accommodate various outside diameters, allowing for use on a large variety of pipe manufacturers.
- Call for details on custom sizes and pricing.

STANDARD GRATES					
CMP or PVC			Corrugated Plastic Tubing		
Size	Grate Item#	Collar Item#	Size	Grate Item#	Collar Item#
4"	GR04	GRC04	4"	GR04	GRC04
6"	GR06	GRC06	6"	GR06P	GRC06P
8"	GR08	GRC08	8"	GR08P	GRC08P
10"	GR10	GRC10	10"	GR10P	GRC10P
12"	GR12	GRC12	12"	GR12P	GRC12P
15"	GR15	GRC15	15"	GR15P	GRC15P
18"	GR18	GRC18	18"	GR18P	GRC18P
24"	GR24	GRC24	24"	GR24P	GRC24P
30"	GR30	GRC30	30"	GR30P	GRC30P
36"	GR36	GRC36	36"	GR36P	GRC36P
42"	GR42	GRC42	42"	GR42P	GRC42P
48"	GR48	GRC48	48"	GR48P	GRC48P

## HEAVY TRAFFIC GRATES

*Built extra strong for heavy traffic.*

- Heavy Traffic Grates are not load rated.
- Grate and collar is designed to fit on the outside of your pipe.
- Durable powder coat finish provides years of service.
- Call for details on custom sizes and pricing.

HEAVY TRAFFIC GRATES					
CMP or PVC			Corrugated Plastic Tubing		
Size	Grate Item#	Collar Item#	Size	Grate Item#	Collar Item#
12"	GRHT12	GRHTC12	12"	GRHT12P	GRHTC12P
15"	GRHT15	GRHTC15	15"	GRHT15P	GRHTC15P
18"	GRHT18	GRHTC18	18"	GRHT18P	GRHTC18P
24"	GRHT24	GRHTC24	24"	GRHT24P	GRHTC24P
30"	GRHT30	GRHTC30	30"	GRHT30P	GRHTC30P
36"	GRHT36	GRHTC36	36"	GRHT36P	GRHTC36P

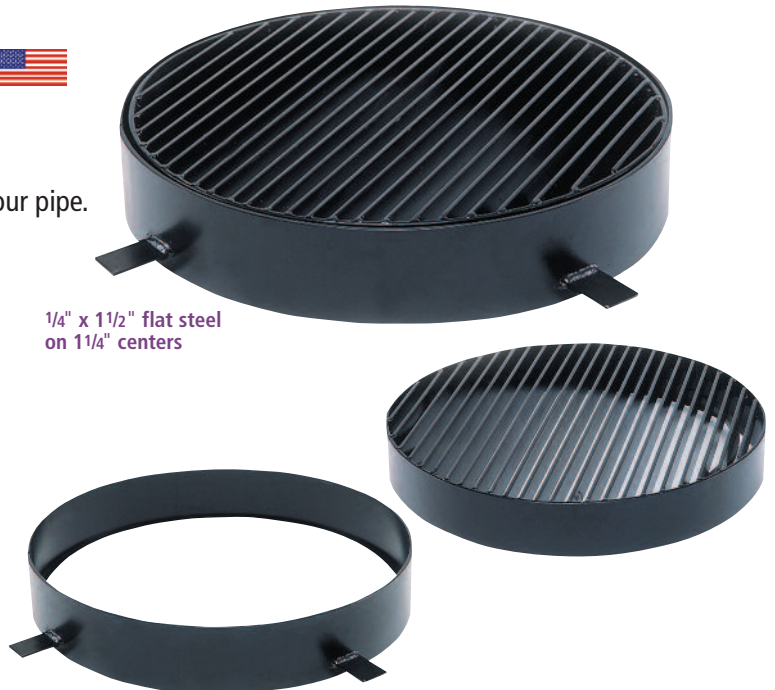

1/4" x 1 1/2" flat steel on 1 1/4" centers

For complete product specifications or questions, visit our website or call our customer service representatives.

More details available online at [www.agridrain.com](http://www.agridrain.com)

# INTAKE MARKER FLAGS

*Great to mark terrace intakes, outlets, hydrants, work sites, and temporary inlets.*

- Mark intakes to increase visibility and avoid costly damage.
- 5/16" coated fiberglass staff.
- Flag is constructed of truck tarp material and is permanently attached to staff.
- Other colors available upon request: blue, green, pink, and purple.
- This product carries a 1-year limited warranty (fluorescent orange carries no warranty due to fading).

**Fluorescent Orange, Orange, Red, White, or Yellow Bundles of 25 (same color/bundle)**

For Survey Marking Flags, see page 34.



Available with 1" x 9" silver reflective strip (call for pricing and details).

Custom printed flags available.

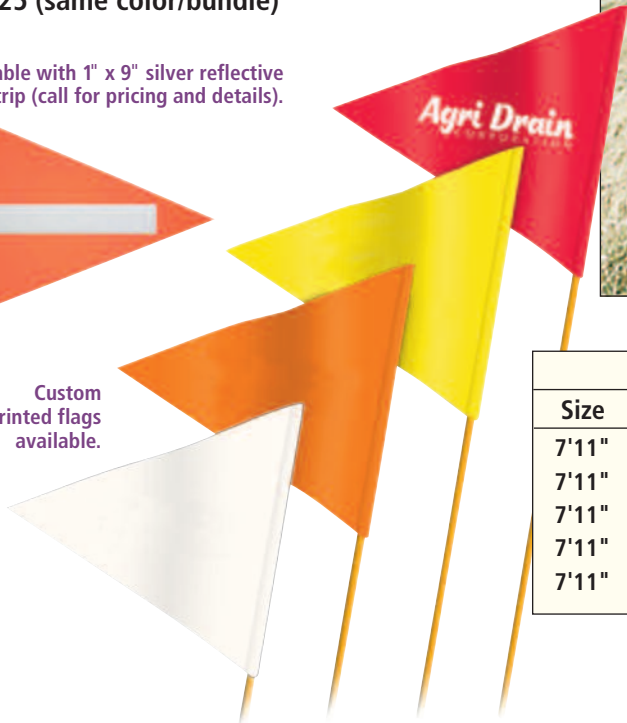

## INTAKE MARKER FLAGS

Size	Item#	Description
7'11"	IMFFO	Fluorescent Orange Flag on Fiberglass Staff
7'11"	IMFO	Orange Flag on Fiberglass Staff
7'11"	IMFR	Red Flag on Fiberglass Staff
7'11"	IMFW	White Flag on Fiberglass Staff
7'11"	IMFY	Yellow Flag on Fiberglass Staff

Quantity discounts available.

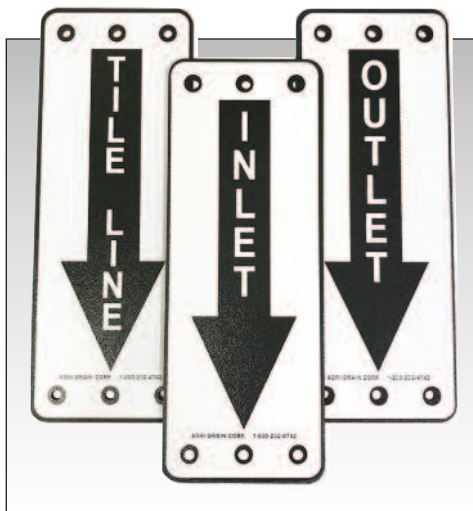

# TILE MARKER SIGNS

*Permanent, heavy-duty "Tile Markers".*

- Plastic signs attach to steel or wooden posts with 1/4" bolt and nut (not included).
- This product carries a 1-year warranty.

## TILE MARKERS & POST

Size	Item#	Description
4 3/8" W x 12" H	TMINLET	Inlet Tile Marker
4 3/8" W x 12" H	TMOUTLET	Outlet Tile Marker
4 3/8" W x 12" H	TMTLINE	Tile Line Marker
6'	TMP06	6', 12-Gauge Galvanized Post

Quantity discounts available.

Call Agri Drain at 1-800-232-4742

# SURFACE INLETS

## WATER QUALITY INLETS

*Farmer-friendly surface inlet: flexible material reduces damage on impact!*

Agri Drain's low-velocity Water Quality Inlets replace standard inlets in farm fields, ditches, dry dams, and terraces. They **resist plugging** and **improve water quality** by filtering debris before it enters the drainage system.

- Available in 4", 6", or 8" diameter in 18" or 36" heights.
- Available in green or yellow.
- 12"-tall mesh sock is installed at the base of the wick to provide additional filtration as soil settles after installation.
- 6"-diameter adapter provides a stable connection to Hickenbottom, Precision, or Quick Drain underground sections, and corrugated plastic tubing. Base will also snap into single-wall corrugated plastic tubing.

6" diameter contains 54 individual wicks.

4" diameter contains 18 individual wicks.

6"-diameter adapter

8" diameter contains 90 individual wicks.

Each wick has .625" OD, .030" wall thickness with .070" slot openings. Material: HDPE

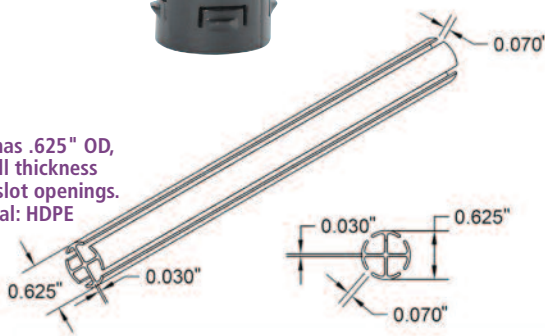

WATER QUALITY INLETS		
Size	Item#	Description
6"	WQI06ADP	6" Adapter, 16 1/2" Tall (5/16" holes)
4"	WQI04G18	4" WQI, Green, 18" Tall
4"	WQI04Y18	4" WQI, Yellow, 18" Tall
6"	WQI06G18	6" WQI, Green, 18" Tall
6"	WQI06Y18	6" WQI, Yellow, 18" Tall
8"	WQI08G18	8" WQI, Green, 18" Tall
8"	WQI08Y18	8" WQI, Yellow, 18" Tall
4"	WQI04G36	4" WQI, Green, 36" Tall
4"	WQI04Y36	4" WQI, Yellow, 36" Tall
6"	WQI06G36	6" WQI, Green, 36" Tall
6"	WQI06Y36	6" WQI, Yellow, 36" Tall
8"	WQI08G36	8" WQI, Green, 36" Tall
8"	WQI08Y36	8" WQI, Yellow, 36" Tall

# PLASTIC INTAKES

*The biggest selection of plastic intakes ever!*

- All parts are manufactured from high-density, heavy-duty polyethylene.
- Agri Drain, Hickenbottom, and Precision Intakes are interchangeable!
- Call for details on custom sizes and pricing.

- A. **PR06X02**, 6" x 2' Poly Riser (Belled) (intermediate section)
- B. **PR06X03**, 6" x 3' Poly Riser (Belled) (intermediate section)
- C. **PR06X04-01**, 6" x 4' Riser with 3 1/2' of 1" holes, 36 holes per foot
- D. **PR06X04-02**, 6" x 4' Riser with 3 1/2' of 2" holes, 24 holes per foot

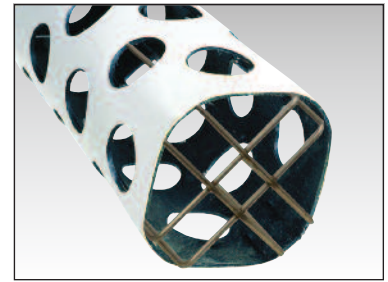

## TRASH GUARDS

- TG06**, 6" Stainless Steel Trash Guard  
*(Included with C & D risers)*
- TG08**, 8" Stainless Steel Trash Guard



QDR08

QDR06

QDR06ADJ

## QUICK DRAIN INTAKES

*Resists plugging from crop residue.*

- Top section available in 6" and 8" size.
- Intake top section can attach to Precision underground sections and tees.
- 6" adjustable, two-piece mid-section can attach to 6" Precision tee and top section.
- Exclusive "open undercuts" allow for additional subsurface drainage!
- Made of UV-stabilized polypropylene.

Diameter at the top: 18".



QDI06 or QDI08

## QUICK DRAIN LOW PROFILE INTAKES

*Maximum drainage at minimum depths.*

- Will fit most existing intakes and can be trimmed to fit dual-wall pipe systems.
- Includes lid with self-tapping screws.
- Low profile allows equipment to pass over.
- Made of UV-stabilized polypropylene.

### QUICK DRAIN INTAKES

Size	Item#	Description	Height	Open Drain Area
6"	QDR06	Quick Drain Intake (6" Body, 6" Inlet)	31 1/2"	116 sq. inches
8"	QDR08	Quick Drain Intake (10" Body, 8" Inlet)	34"	356.14 sq. inches
6"	QDR06ADJ	Quick Drain Adjustable Mid-Section	28"-40"	Exterior portion: 1/4" x 1" slots Exterior portion: 5/16" slots
6"	QDI06	Quick Drain Low Profile Intake	17"	
8"	QDI08	Quick Drain Low Profile Intake	17"	

Call Agri Drain at 1-800-232-4742

# SURFACE INLETS

## PRECISION INTAKES

- Bright yellow color.
- Available in 6", 8", and 10".
- Each part features exclusive twist-lock design and maximum height adjustability.
- Constructed of high-density polyethylene.
- Meets ASTM F405 specifications.

PRECISION INTAKES							
Top Section 1 (1" holes)			Mid Section 2 (5/16" holes)	Solid Section	Slotted Section (1" x 4" slots)	Blind Tee	Restrictor
Size	Item#	Holes/ft.	Item#	Item#	Item#	Item#	Item#
6"	PI06-01	40-1"	PI06	PI006	PIWS06	PIT06	PIR06
8"	PI08-01	60-1"	PI08	PI008	PIWS08	PIT08	PIR08
10"	PI10-01	72-1"	PI10	PI010	PIWS10	PIT08	PIR10



**6" Top Section 1:** 38" tall with molded cap. Can be cut in half to adjust height. (4 per bundle)

**6" Mid Section 2:** 38" tall with 5/16" holes. Can be cut approx. every 4" to adjust height. (4 per bundle)

**6" x 5" x 4" Blind Reducing Tee:** Can be cut to allow 4", 5", and 6" tile hookup.

**6" Restrictor for Precision Intake:** Adjust the flow of water from the inlet to the main line.



**8" Top Section 1:** 38" tall with molded cap. Can be cut in thirds to adjust height.

**8" Mid Section 2:** 38" tall with 5/16" holes. Can be cut in thirds to adjust height.

**10" x 8" Blind Reducing Tee:** Can be cut to allow 8" and 10" tile hookup.

**8" Restrictor for Precision Intake:** Adjust the flow of water from the inlet to the main line.



**10" Top Section 1:** 38" tall with molded cap. Can be cut in thirds to adjust height.

**10" Mid Section 2:** 38" tall with 5/16" holes. Can be cut in thirds to adjust height.

**10" x 8" Blind Reducing Tee:** Can be cut to allow 8" and 10" tile hookup.

**10" Restrictor for Precision Intake:** Adjust the flow of water from the inlet to the main line.

# HICKENBOTTOM INTAKES

- Bright orange color.
- Available in 5", 6", 8", 10", and 12".
- Each part snaps together and can be cut in half to adjust height.
- Top sections have a molded cap.
- Constructed of high-density polyethylene.
- Meets ASTM F405 specifications.



Place a Bar Guard in the top of your riser for a low-profile, high-capacity, debris-resistant intake. (See page 16.)

Slotted Sections available in → 5"-12" sizes (shown in 5" size).

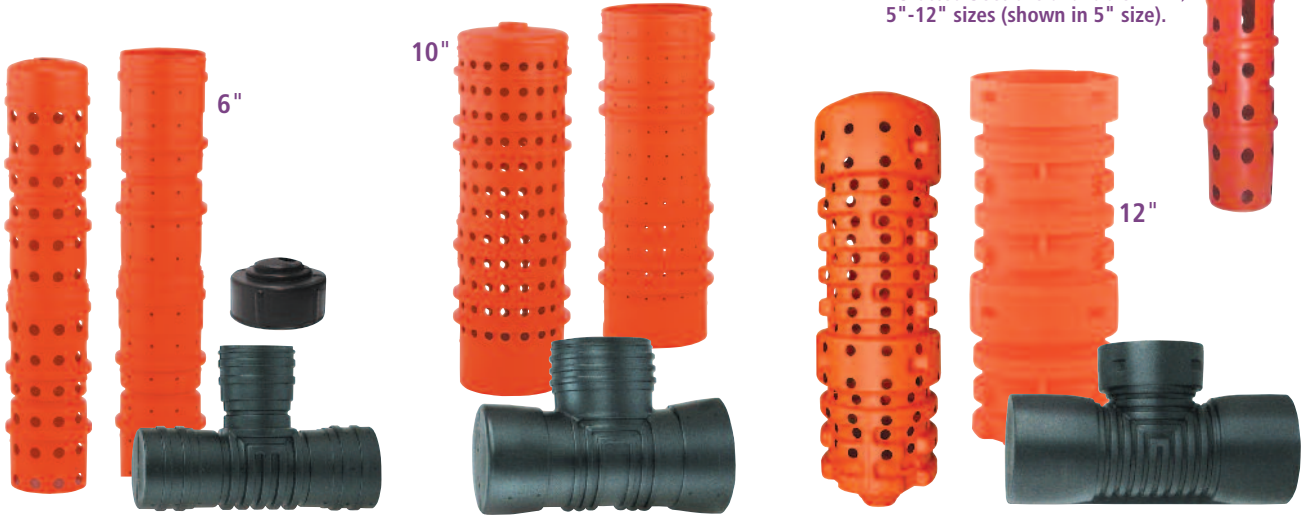

HICKENBOTTOM INTAKES									
Top Section 1 (1" holes)				Mid Section 2 (5/16" holes)		Solid Section	Slotted Section (1" x 4" slots)	Blind Tee	Restrictor
Size	Item#	Holes/ft.	Height	Item#	Height	Item#	Item#	Item#	Item#
5"	HB05-01 4/bundle	24-1"	36"	HB05 4/bundle	36"	HBO05	HBWS05	HBT05 16/bundle	HBR05
6"	HB06-01 4/bundle	40-1"	36"	HB06 4/bundle	36"	HBO06	HBWS06	HBT06 8/bundle	HBR06
8"	HB08-01 2/bundle	60-1"	40"	HB08 2/bundle	40"	HBO08	HBWS08	HBT08	HBR08
10"	HB10-01 2/bundle	72-1"	40"	HB10 2/bundle	40"	HBO10	HBWS10	HBT10	HBR10
12"	HB12-01	72-11/4"	42"	HB12	42"	HBO12	HBWS12	HBT12	HBR12



## 1" PLUG ITS™

- For use in 5" through 10" intake top sections.
- Insert to adjust amount of holes in top section depending on flow rate required for project.

HBI-PLUG, Bag of 50

## INCREASERS & REDUCERS

- Increases allow easy transition from a smaller diameter tee to a larger diameter riser.
- Reducers allow easy transition from a larger diameter tee to a smaller diameter riser.



HBI0608I

HBI0610I

HBI0810I



HBI0806R



HBI1006R



HBI1008R

Call Agri Drain at 1-800-232-4742

# SURFACE INLETS

## STANDARD STEEL RISERS

- Made of 18-gauge corrugated steel.
- All Steel Risers include a stainless steel Trash Guard.
- Call for details on custom sizes and pricing.

### A. 8" x 6' Steel Riser with 4' of 1" holes

SR08X06-12, 12 holes per foot

SR08X06-24, 24 holes per foot

SR08X06, 36 holes per foot

### B. 8" x 5' Steel Riser with 3 1/2' of 1" holes

SR08X05-12, 12 holes per foot

SR08X05-24, 24 holes per foot

SR08X05, 36 holes per foot

### C. 6" x 6' Riser with 4' of 1" holes

SR06X06-12, 12 holes per foot

SR06X06, 24 holes per foot

### D. 6" x 5' Riser with 3 1/2' of 1" holes

SR06X05-12, 12 holes per foot

SR06X05, 24 holes per foot

### E. 6" x 4' Riser with 3' of 1" holes

SR06X04, 24 holes per foot

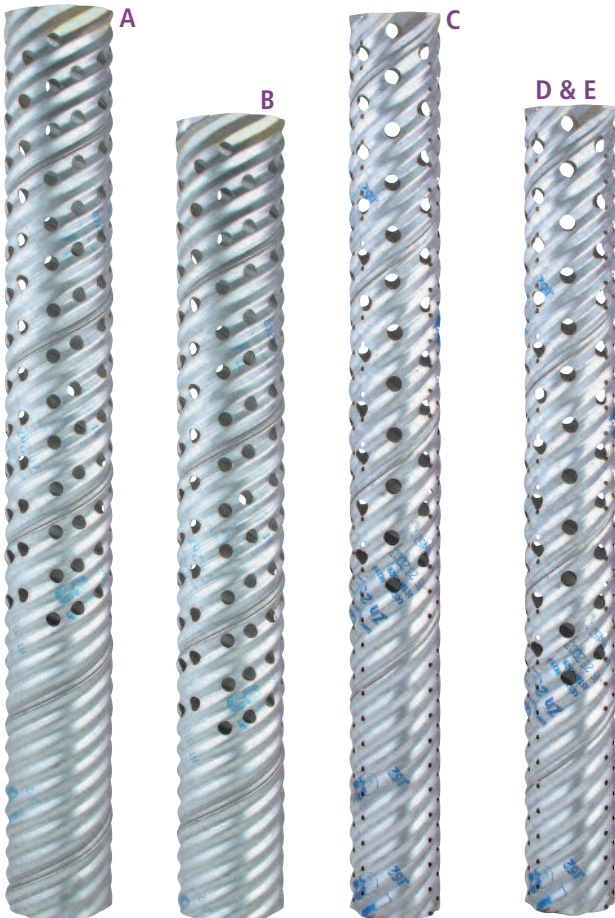

## STANDARD STEEL INTAKES

- Features 6" x 6' Steel Riser with 4' of 1" or 3/4" drilled holes and a stainless steel Trash Guard.
- Choose either 12 holes per foot or 24 holes per foot.
- All 4" material is SCH40 PVC.
- Intakes include a heavy flex coupling for adjustability.

### 6" x 6' Steel Riser, 4' of 1" holes, 5' flow pipe

SI0605-12, 12 holes per foot

SI0605, 24 holes per foot

### 6" x 6' Steel Riser, 4' of 3/4" holes, 5' flow pipe

SI0605-12 3/4, 12 holes per foot

### 6" x 6' Steel Riser, 4' of 1" holes, 8' flow pipe

SI0608, 24 holes per foot



Trash Guards are a standard feature on all Steel Risers.



Flex coupling allows for easy riser adjustment, both vertically and horizontally.





# HEAVY DUTY STEEL CATCH BASINS

*Hooks up easily to almost any pipe.*

- Heavy Duty Steel Catch Basins are not load rated.
- Heavy  $\frac{3}{16}$ " steel construction.
- Narrow-spaced grate for safety.
- 6" extensions let you customize to fit the job.
- Quality powder coated finish resists corrosion.
- Call for details on custom sizes and pricing.
- Custom or nonstandard items carry a 1-year warranty on material and workmanship and are nonreturnable.

Picture shown with the 14" box with a 4" stub, grate, and optional extension.

### 14" Grate

- Constructed of  $\frac{1}{4}$ " steel.
- $1\frac{1}{2}$ " in height.
- Slots are  $\frac{1}{2}$ " wide and comply with the American Disabilities Act.

### 26" Grate

- Constructed of  $\frac{1}{4}$ " steel.
- $1\frac{1}{2}$ " in height.
- Slots are  $\frac{1}{2}$ " wide.
- Reinforced by six  $\frac{1}{2}$ "-thick crossbars.

### Extension

- 6" tall.
- 2" x  $\frac{1}{4}$ " top frame.
- $\frac{3}{16}$ "-thick side plates.
- $\frac{1}{4}$ " x  $1\frac{1}{2}$ " x 4" handles.

### Catch Basin Box

- 2" x  $\frac{1}{4}$ " top frame.
- $\frac{3}{16}$ "-thick side plates.
- 6"-long 12-gauge steel stub.

CATCH BASIN BOXES	
Item#	Description
CB04	14" Catch Basin & 4" Stub
CB06	14" Catch Basin & 6" Stub
CB08	14" Catch Basin & 8" Stub
CB10	14" Catch Basin & 10" Stub
CB12	14" Catch Basin & 12" Stub
CB15	26" Catch Basin & 15" Stub
CB18	26" Catch Basin & 18" Stub
CB24	26" Catch Basin & 24" Stub
CATCH BASIN BOXES, NO STUBS	
CBB14	14" x 14" x 14" Catch Basin, No Stub
CBB26	26" x 26" x 26" Catch Basin, No Stub
CATCH BASIN EXTENSIONS	
CBE14	Catch Basin Ext./14" Box
CBE26	Catch Basin Ext./26" Box
CATCH BASIN GRATES	
CBG14	Catch Basin Grate 14"
CBG26	Catch Basin Grate 26"
ADDITIONAL CATCH BASIN STUBS	
700778	4" Catch Basin Stub
700779	6" Catch Basin Stub
700780	8" Catch Basin Stub
700781	10" Catch Basin Stub
700782	12" Catch Basin Stub
700783	15" Catch Basin Stub
700784	18" Catch Basin Stub
700785	24" Catch Basin Stub

(15" and larger stubs can only be placed on the 26" box.)

# SERVICE & AFFILIATES

## COMMITTED TO CUSTOMER SERVICE SINCE 1976!

*Our Customer Service Team is ready, willing, and able to answer your questions and take your order!*

**Email:** [info@agridrain.com](mailto:info@agridrain.com)

**Fax:** 1-800-282-3353 or 1-641-742-5222

**Call:** 1-800-232-4742 or 1-641-742-5211

*Hours are Monday – Friday,  
7:00 am – 5:00 pm CST.*

*After regular business hours, you may leave a message and we will return your call as soon as possible.*

Our dedicated and talented employees work in our well-equipped, state-of-the-art, 84,000-square-foot plant. You will receive exceptional quality products and the best service in everything we do.



## Agri Drain Offers the Best Guarantee in America!

It's simple—we take care of our customers! You must be completely satisfied with every Agri Drain manufactured product that you order from us. If there's ever a problem, we'll solve it immediately with a replacement, credit, or refund for 5 full years unless otherwise stated. If there's something you don't want, we'll have it picked up and will pay the freight. Custom or nonstandard items built to your specifications carry a 1-year warranty on material and workmanship and are nonreturnable. Agri Drain disclaims any liability for any products not manufactured by Agri Drain, and purchaser is directed to the warranty, if any, provided by the manufacturer of such products. No other warranty is expressed and none shall be implied, including, without limitation, the warranty of merchantability or warranty of fitness for use or for a particular purpose. See our website for full warranty details.

## EASY CREDIT TERMS

- We want to do business with you, and we trust our customers. Bank references aren't necessary on most orders. All we ask is for you to promise to pay your bill within 30 days.
- Online ordering available. Pay by credit card or bill to account.
- MasterCard, VISA, Discover, and American Express are accepted for up to \$3,000 orders (at the time of order only). E-Check, OR pay within 30 days by check from your invoice. Credit Card payments are not accepted for tile and fittings purchases.
- Prices subject to change without notice.
- Attention Federal Government: We are registered with the CCR/SAM.

## SHIPPING

*Most orders received by 2:00 p.m. ship the same day.*

We maintain a large inventory at all times, which makes backorders practically nonexistent. We use a variety of small package shipping companies, and we also have a number of commercial trucking companies at our disposal. Shipping charges are billed to our customers as a separate item on the invoice.

For faster service, we also offer 1, 2, and 3-Day Air.

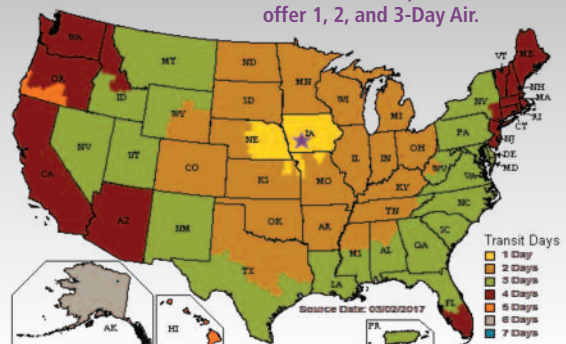



## CUSTOM FABRICATION

Agri Drain offers a wide variety of custom fabrication options. We work in a well-equipped, state-of-the-art, 84,000-square-foot plant.

With over 45 years of experience, we stand ready for anything you send us.

Call us with your specifications at **1-800-232-4742** for a free quote on any of your fabrication needs.



The well-stocked wholesale plumbing supply company! Never stand in line again! Same great service! Satisfaction guaranteed!

**1-800-243-7473 or  
www.jacobseninc.com**



## THE LAND IMPROVEMENT CONTRACTORS OF AMERICA

LICA has been serving contractors for over 60 years, providing members with the benefits they need to work "Smarter not Harder".



**Call Agri Drain at 1-800-232-4742**

# EQUIPMENT & TOOLS

## MANUAL MAXI STRINGER TRAILERS

*These rugged trailers load a full or partial roll with precision and ease, and are easy to maneuver!*

### Standard Manual Trailers

#### Features:

- Industrial electric over hydraulic 12-volt power unit.
- Durable powder coat finish, available in yellow, blue, green, and red. Other colors may be available.
- Remote retrofit available for manual trailer.
- This product carries a 1-year warranty.  
See our website for full warranty details.

#### Specs:

- Tongue rails are 2" x 3", wheel base is 6'4".
- 10'7"-diameter table, stinger diameter is 6".
- Overall length: 16'4", overall height: 12'.
- Weight: 1,635 lbs.
- Radial tires are highway rated.  
Tire size is ST205 175R15.
- Comes with hitch pin.  
(Ball hitch or pintle hook available.)
- Note: Trailers do not come with a plug end for your vehicle to power trailer lights.

### Heavy Duty Manual Trailers

#### Features:

- Same features as shown above.

#### Specs:

- Tongue rails are 2" x 6", wheel base is 6'4".
- 10'7"-diameter table, stinger diameter is 10".
- Overall length: single-16'4", tandem-15'8".
- Overall height: 12'4".
- Weight: single-1,895 lbs., tandem-2,100 lbs.
- Tandem has two 3,500-lb. fixed axles.
- Large flotation tires are highway rated; recommended max speed of 30 mph. Tire size is 11L-15FI.
- Heavy-duty 5-position adjustable hitch.
- Note: Trailers do not come with a plug end for your vehicle to power trailer lights.

MANUAL MAXI STRINGER TRAILERS	
Item#	Description
MAXISYPC	Standard, Single Axle, Manual–Yellow
MAXIPM	Standard, Pickup Mount, Manual–Yellow
MAXIHDSYPC	Heavy Duty, Single Axle, Manual–Yellow
MAXIHDTYPC	Heavy Duty, Tandem Axle, Manual–Yellow
MAXIPMHD	Heavy Duty, Pickup Mount, Manual–Yellow

F.O.B., Adair, IA

Standard, Single Axle, Manual



Heavy Duty, Manual Available in Single or Tandem Axle



Manual Tension Brake



Pickup Mount Available in Standard or Heavy Duty (Pictured: Heavy Duty)



# REMOTE MAXI STRINGER TRAILERS

*Agri Drain's wireless remote trailer lets you load and unload rolls of tile from the comfort of your truck!*

## Standard & Heavy Duty Remote Trailers

- Same features and specs as manual trailers.
- Wireless remote raises and lowers the table or applies the hydraulic brake.
- Wireless remote has 100' range.
- Manual override allows the ability to operate trailer manually.
- Waterproof receiver/transmitter.
- Trailer Battery Charging Module extends battery life, eliminates overcharging batteries or the need for jumper cables (included with remote trailer, optional for manual trailer).

REMOTE MAXI STRINGER TRAILERS	
Item#	Description
<b>MAXISYPCR</b>	Standard, Single Axle, Remote–Yellow
<b>MAXIPMR</b>	Standard, Pickup Mount, Remote–Yellow
<b>MAXIHDSYPCR</b>	Heavy Duty, Single Axle, Remote–Yellow
<b>MAXIHDTYPCR</b>	Heavy Duty, Tandem Axle, Remote–Yellow
<b>MAXIPMHDR</b>	Heavy Duty, Pickup Mount, Remote–Yellow

F.O.B., Adair, IA

## TRAILER ACCESSORIES

TRAILER ACCESSORIES	
Item#	Description
<b>800646</b>	Battery Charging Module
<b>TRAILERBATTERY</b>	12-Volt, Deep Cell Battery
<b>801199</b>	Additional Remote Key Fob
<b>CASTERREPLACE</b>	Caster Replacement

Quantity discounts available for Item# 800646

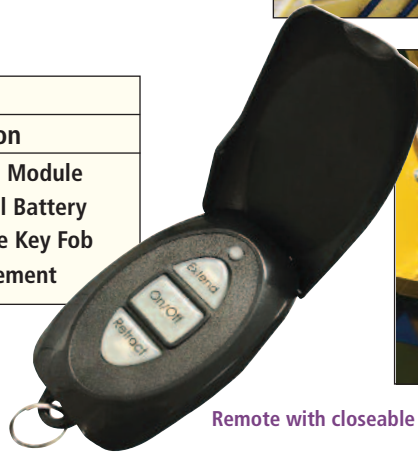

Remote with closeable cover!

Standard, Single Axle, Remote



Hydraulic Brake

Industrial Pump & Battery Charging Module

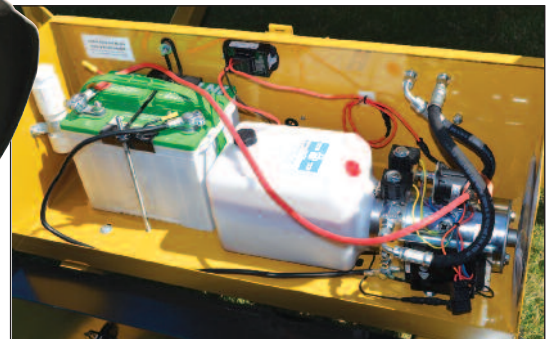

## STANDARD & HEAVY DUTY MAXI SPOOLS

*The perfect accessory for your Agri Drain Maxi Stringer trailer.*

- No more struggling with piles of partial maxi coils.
- Maxi Spools keep partial rolls in good condition and ready for use.
- Durable powder coat finish, available in various colors.

*Need a different size than what you're using? Just unload the unused portion of the coil along with the Maxi Spool and insert the next Maxi Spool with the right size.*

**MAXISPY, Standard Maxi Spool**  
**MAXIHDSPY, Heavy Duty Maxi Spool**

Standard Spool has 8" diameter.  
 Heavy Duty Spool has 12" diameter.

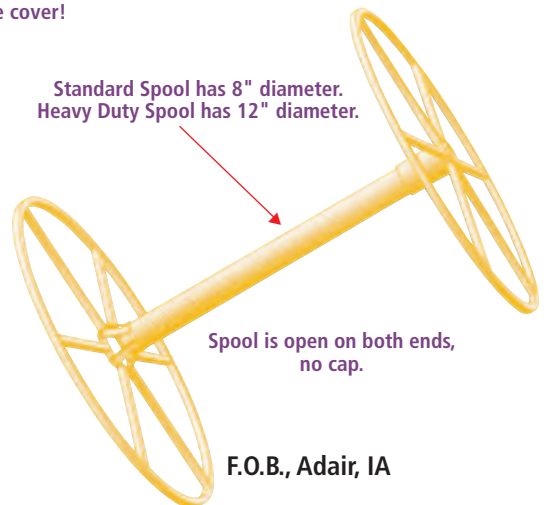

Spool is open on both ends, no cap.

F.O.B., Adair, IA

Call Agri Drain at 1-800-232-4742

# EQUIPMENT & TOOLS

## PROBES

- Stainless steel.
- Cushioned, rubber handles for greater comfort.

STANDARD PROBES		
Size	5/16" Diameter Rod Item#	3/8" Diameter Rod Item#
3'	TP03	TP03HD
4'	TP04	TP04HD
4 1/2'	TP04.5	TP04.5HD
5'	TP05	TP05HD
6'	TP06	TP06HD
8'	TP08	TP08HD

POWER PROBES*				
Size	5/16" Diameter Rod Item#	3/8" Diameter Rod Item#	Length	
			Closed:	Extended:
4 1/2'	TP04.5P	TP04.5HDP	62 1/4"	67 1/4"
5 1/2'	TP05.5P	TP05.5HDP	74"	79 1/2"

\*Weighted handle works like a post driver to power the probe in.

Rounded, welded tip helps prevent puncture!



Standard Probe

Power Probe



Rice Shovel & Scoop Shovel have PermaGrip™ steel collars that connect the shovel neck, handle, and fiberglass PowerCore™ rod, making it one solid unit. Provides the strongest head to handle connection.

NSLRC

NSSC

NSLTC4

NSLTC5

## SPECIALTY SHOVELS

### Rice Shovel

- 16-gauge steel head, 48" fiberglass handle with cushion grip.
- Forward-turned step for foot comfort and easier penetration.
- Perforations in shovel head allow draining and ease of suction break when used for irrigation.

### Scoop Shovel

- #2 steel head, 11" x 13.5".
- 29" premium fiberglass handle with poly d-grip.

### Clean Out/Trenching Shovels

- 14-gauge tempered steel head.
- 48" polymer handle with solid fiberglass reinforcing core.
- Forward-turned steps on 5" Trenching Shovel for foot comfort and easier penetration.



Know what's below.  
Call before you dig.  
Within the US, Call: 811  
[www.call811.com](http://www.call811.com)

SPECIALTY SHOVELS	
Item#	Description
NSLRC	Rice Shovel
NSSC	Scoop Shovel
NSLTC4	Clean Out/Trenching Shovel, 4"
NSLTC5	Clean Out/Trenching Shovel, 5"

Quantity discounts available.

 WARNING: Cancer and Reproductive Harm—[www.P65Warnings.ca.gov](http://www.P65Warnings.ca.gov)

More details available online at [www.agridrain.com](http://www.agridrain.com)

# SHOVELS & SPADES

*Excellent rigidity reduces wasted effort.*

- Heavy 14-gauge blades with hollow-back construction.
- Forward-turned steps for foot comfort and easier penetration (excludes Super Crummer—NSSC).
- Does not absorb moisture; resists industrial chemicals.
- Easily cleaned of concrete, tar, etc.
- Easy to handle in extreme temperatures.
- Ergonomic design for comfort and stress reduction.



SHOVELS & SPADES	
Item#	Description
NSSC	Super Crummer
NSSF	Flat Shovel, Short Handle
NSLF	Flat Shovel, Long Handle
NSSS	Spade, Short Handle
NSLS	Spade, Long Handle
NSSR	Shovel, Short Handle
NSLR	Shovel, Long Handle
NSSHO	Replacement Handle, Short
NSLHO	Replacement Handle, Long

Quantity discounts available.

**⚠ WARNING:** Cancer and Reproductive Harm— [www.P65Warnings.ca.gov](http://www.P65Warnings.ca.gov)

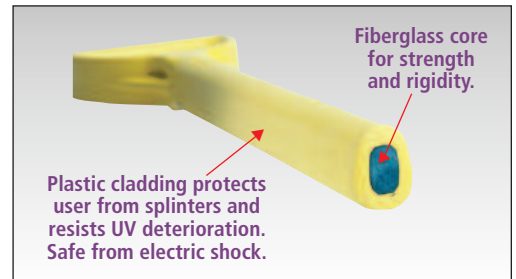

# MUD SLINGERS

*Give our Mud Slingers a try—you will be amazed at the superior mud-release!*

- Holes in blade allow for superior mud-release.
- The blade is almost 1 pound lighter than regular spades and shovels.
- Solid, fiberglass core handle.



MUD SLINGERS	
Item#	Description
NSMS	Mudslinger, Super Short Handle
NSSFMS	Flat Shovel Mudslinger, Short Handle
NSLFMS	Flat Shovel Mudslinger, Long Handle
NSSRMS	Shovel Mudslinger, Short Handle
NSLRMS	Shovel Mudslinger, Long Handle
NSSSMS	Spade Mudslinger, Short Handle
NSLSMS	Spade Mudslinger, Long Handle

Quantity discounts available.

Call Agri Drain at 1-800-232-4742

# SURVEY EQUIPMENT

Shown with receiver (sold separately).



## SPECTRA PRECISION LASER LEVELS

### LL300S, Manual Grade Laser Level

*Automatic self-leveling level with manual grade capabilities.*

- Accuracy 1/16" at 100', working range 2,600' diameter.
- Arrow buttons offer easy grade matching with controlled slope setup using the HI-alert function.
- Includes LL300S, hard-shell carrying case, and 4 D Cell Alkaline batteries.
- 5-year warranty.

**LL300S, Manual Grade Laser Level**  
**LL400R, RC402N Radio Remote Control**



### GL412N Digital Grade Laser Level

*Automatic self-leveling level with digital readout grade capabilities.*

- Accuracy 1/16" at 100', working range 2,600' diameter.
- Single slope grade laser with digital readout.
- Includes long-range RC402N radio remote control up to 330' with digital readout.
- Accurate even in high winds or on high-vibration job sites with "Selection of Sensitivity" settings.
- Includes GL412N, hard-shell carrying case, RC402N remote, and rechargeable battery cassette.
- 5-year warranty.

**GL412, Digital Grade Laser Level**

GL412N



## SPECTRA PRECISION HL760 SURVEY RECEIVER

- HL760 Digital Readout (DRO) receiver features a unique "Fingerprint" function that only accepts the beam from the laser it is paired with.
- Readout is displayed on the large front and rear LCDs.
- Waterproof.
- Includes HL760, bracket for survey rod, and batteries.
- 3-year warranty on all parts and labor. (For bracket, 1-year warranty from date of purchase on material and workmanship.)

**RECVR6, HL760 Laserometer with Bracket**



## AGL MR360R LASER RECEIVER

*Machine-mounted receiver with wireless remote display.*

- 360° detection of any rotating laser from any angle.
- Wireless RF technology links the remote in-cab display to the receiver.
- In-cab display allows you to view the LED channel indicators.
- Built-in plumb indicator monitors angle of the stick, signaling if it's plumb or under or over-extended.
- Rugged, waterproof construction. Built-in shock mounts minimize machine vibrations.
- Includes MR360R rechargeable receiver with magnet or clamp mount, hard-shell carrying case, 110/240V charger for MR360R, MD360R remote display with 12-24V power cord with accessory plug, suction cup (for MD360R mount), and user manual.
- 2-year warranty on receiver parts and labor.
- 1-year warranty on accessories.

**MR360R, Laser Receiver**



## TRIPOD

- Heavy duty, flat head, fiberglass tripod.
- Adjustable legs with quick release clamps.
- Tripod height when closed: 42", fully extended: 72".

**TRIFH, Flat-head, Fiberglass Tripod**





All lasers are re-checked for calibration prior to shipment. Technical support, calibration, and repair services available. Additional survey equipment models available upon request.

## GRADE GAUGES™

*Measure slopes precisely.*

- Get fast, accurate control when grading slopes.
- Grade Gauges are easy to use, weather resistant, and can mount on tiling machines, bulldozers, scrapers, or any piece of construction equipment.
- Size: 3" high, 9<sup>3</sup>/<sub>4</sub>" wide, and 3<sup>3</sup>/<sub>4</sub>" deep.
- Ideal for construction of terraces, roadways, backslopes, waterways, dams, and front slopes.
- Keep out of direct sunlight or extreme heat.
- This product carries a 1-year warranty.

**GG1000 or GG3000**

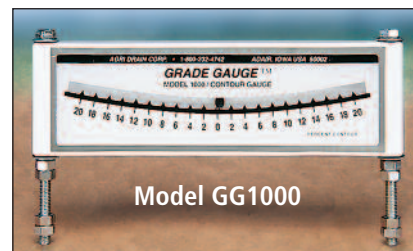

The 1000 model reads out in percent of grade, commonly used with tiling machines and road graders.

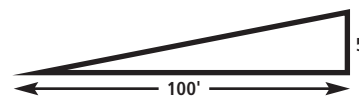

(For every 100' of travel there is a 5' change in elevation, resulting in a 5% grade.)

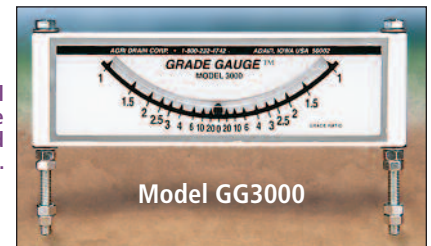

The 3000 model reads out in slope ratio, commonly used with bulldozers.



(For every 4' of travel there is a 1' change in elevation, resulting in a 4 to 1 slope ratio.)

## SPECTRA PRECISION CR700 SURVEY RECEIVER

- 270° wraparound photocells.
- Super-bright LED display.
- Heavy-duty die-cast magnesium, fully waterproof.
- Includes CR700, bracket for survey rod, magnetic mount for use on machine, and batteries.
- 2-year warranty on all parts and labor. (For bracket, 1-year warranty from date of purchase on material and workmanship.)



**RECVR4, CR700 Survey Receiver with Bracket**

## SURVEY RODS

- Inches or tenths. (Specify when ordering.)
- Positive locks on each section help eliminate mistakes.
- Made of lightweight fiberglass.
- Shaped for easy reading all the way to the top.
- Replacement sections are available.
- Comes with cloth case.

**A. 16' Rectangular Fiberglass Rod (folded length: 56<sup>3</sup>/<sub>4</sub>"**

**SRI16 (Inches) or SRT16 (Tenths)**

**20' Rectangular Fiberglass Rod (folded length: 58"**

**SRI20 (Inches) or SRT20 (Tenths)**

**B. 25' Oval Fiberglass Rod (folded length: 66"**

**SRI25 (Inches) or SRT25 (Tenths)**

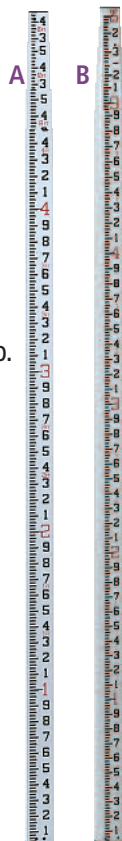

## HAND LEVEL

*Objective lens and eyepiece slide for easy focusing. Provides accuracy at greater distances.*

5<sup>1</sup>/<sub>2</sub>" to 6<sup>1</sup>/<sub>2</sub>" length. Very sharp field of view and a stadia ratio of 1:40. The exterior has a highly visible baked-orange acrylic finish. Case is included.

**2X, 2 power**

Quantity discounts available.

Keep out of direct sunlight or extreme heat.



Call Agri Drain at 1-800-232-4742

# SURVEY EQUIPMENT

## FLAGSHOOTER & FLAGS



Quantity discounts available.

UPSIDE DOWN MARKING PAINTS	
Item#	Color
UPW	A.P.W.A. White
UPBU	A.P.W.A. Blue
UPO	A.P.W.A. Orange
UPR	A.P.W.A. Red
UPY	A.P.W.A. Yellow
UPG	A.P.W.A. Green
UPFRO	Fluorescent Red/Orange
UPFO	Fluorescent Orange
UPFR	Fluorescent Red
UPFP	Fluorescent Pink
UP34	34" Striping Stick
UP12	12" Marking Pistol

*Saves you time, money, and energy!*

- Easily shoot marking flags into hard or frozen ground.
- Measures 8" x 3" x 32". Dry weight is 3.2 lbs.
- Flag capacity is 25 flags at-ready and 50-75 extra flags in the quiver.
- Uses patented marking flags (sold separately).
- Flags offered in blue, clear, glow lime, glow pink, green, orange, purple, red, white, and yellow.
- Sold in bundle quantities of 1,000 (same color/bundle).
- Custom printed flags available. Call for details on pricing and to set up imprint.

## UPSIDE DOWN MARKING PAINTS

- Water-based—17 oz. cans.
- Lower VOC than solvent-based products.

**⚠ WARNING:** This product contains chemicals known to the State of California to cause cancer and birth defects or other reproductive harm. Go to [www.P65Warnings.ca.gov](http://www.P65Warnings.ca.gov)

**FSHOOTER, FlagShooter**  
**FSHOOTERC, FlagShooter with can holster**  
 5" x 6" flag with 23" steel wire  
 5" x 6" flag with 33" steel wire



Shown with optional can holster for upside down marking paint.

## SURVEY MARKING FLAGS

- Offered in fluorescent orange, lime green, fluorescent pink, red, white, blue, yellow, and orange.
- Can be used for surveying, landscaping, underground utilities, and sewers.
- Sold in case quantities of 1,000 (10 bundles) or bundles of 100 (same color/bundle).
- Custom printed flags available. 1,000 quantity minimum (same color/1,000 flags). Call for pricing.

SURVEY MARKING FLAGS		
Size	Item#	Description
2.5"x3.5" Flag, 21" Wire Staff	SFB21	Blue Flag, Qty of 100/bundle
2.5"x3.5" Flag, 21" Wire Staff	SFFG21	Fluorescent Lime Green Flag, Qty of 100/bundle
2.5"x3.5" Flag, 21" Wire Staff	SFFO21	Fluorescent Orange Flag, Qty of 100/bundle
2.5"x3.5" Flag, 21" Wire Staff	SFFP21	Fluorescent Pink Flag, Qty of 100/bundle
2.5"x3.5" Flag, 21" Wire Staff	SFO21	Orange Flag, Qty of 100/bundle
2.5"x3.5" Flag, 21" Wire Staff	SFR21	Red Flag, Qty of 100/bundle
2.5"x3.5" Flag, 21" Wire Staff	SFW21	White Flag, Qty of 100/bundle
2.5"x3.5" Flag, 21" Wire Staff	SFY21	Yellow Flag, Qty of 100/bundle
4"x5" Flag, 36" Wire Staff	SFB	Blue Flag, Qty of 100/bundle
4"x5" Flag, 36" Wire Staff	SFFG	Fluorescent Lime Green Flag, Qty of 100/bundle
4"x5" Flag, 36" Wire Staff	SFFO	Fluorescent Orange Flag, Qty of 100/bundle
4"x5" Flag, 36" Wire Staff	SFFP	Fluorescent Pink Flag, Qty of 100/bundle
4"x5" Flag, 36" Wire Staff	SFO	Orange Flag, Qty of 100/bundle
4"x5" Flag, 36" Wire Staff	SFR	Red Flag, Qty of 100/bundle
4"x5" Flag, 36" Wire Staff	SFW	White Flag, Qty of 100/bundle
4"x5" Flag, 36" Wire Staff	SFY	Yellow Flag, Qty of 100/bundle



Quantity discounts available.

More details available online at [www.agridrain.com](http://www.agridrain.com)

# ENGINEERING FABRIC

- Polypropylene, staple fiber, needle punched nonwoven geotextile.
- Needled fibers form a network that retains dimensional stability.
- Resists UV deterioration, rotting, biological degradation, naturally encountered basics, and acids.
- Polypropylene is stable within a pH range of 2 to 13.
- Larger quantity discounts available.

## 3.5-oz. Fabric

T1114-12, 12<sup>1</sup>/<sub>2</sub>' x 360' rolls (500 sq. yards)

T1114-15, 15' x 360' rolls (600 sq. yards)

## 6-oz. Fabric

T1120-12360, 12<sup>1</sup>/<sub>2</sub>' x 360' rolls (500 sq. yards)

T1120-15, 15' x 300' rolls (500 sq. yards)

Quantity discounts available.



**KNIFE, Construction Fabric Knife**



# EROSION CONTROL

## BIODEGRADABLE STRAW BLANKET

- Made from straw fibers mechanically stitch-bonded to netting, Landlok S1 short-term degradable blanket is ideal for use on moderate slopes with light runoff conditions. S1 comes with a photodegradable netting on the top side.
- Standard roll size for these styles is 8' x 112.5' with 100 sq. yards per roll.
- Thickness: 12.7 mm.
- Tensile Strength – Machine Direction: 122.4 lb./in.
- Elongation – Machine Direction: 36.1%.
- Mass Per Unit Area: 9.76 oz./sq. yard.
- Functional Longevity: up to 12 months.

### SMS1, Biodegradable Straw Blanket

Other types available upon request.

Quantity discounts available.



## STRAW WATTLE

- 9" x 25' roll.
- Made of HDP photodegradable netting with a .5 diamond mesh.
- Use in a variety of applications for sediment control including perimeter and inlet control, waterways and preventing runoff from a jobsite.
- Simply stake in to the ground during use.
- Can be cut and joined together to fit any project.
- Made of natural and biogradable materials, so clean-up is unnecessary.
- Using at least 5 stakes per roll, one stake every 5', is recommended.
- Simply stake in to the ground during use. Stakes sold separately in bundles of 20 stakes.



### SW9X25, 9" x 25' Straw Wattle Roll

### SWSTAKES, 18" Wooden Stakes (20/bundle)

Quantity discounts available.

# EROSION CONTROL

## WATERWAY FABRIC PLOW

- 36" fabric chute and positive feed design allows fabric to be sliced into ground with little soil disturbance.
- Rugged-built machine to fit any needs for waterway fabric installation.
- Plow comes with either skid loader mounting, or three-point hitch mounting (must specify when ordering).

### SFPR, Waterway Fabric Plow



## WATERWAY FABRIC

- Made from nonwoven, polypropylene fibers that are needle punched to form strong fabric that retains dimensional stability.
- Resistant to ultraviolet degradation and biological and chemical environments normally found in soils.
- Helps prevent water from cutting a ditch in the waterway.
- Protects waterway during grass establishment.

**SF03X600, 3' x 600' Waterway Fabric (3.5 oz)**  
Quantity discounts available.

## ANTI-WASH®/GEOJUTE®

*Control your erosion problem the natural way.*

- ANTI-WASH®/GEOJUTE® controls erosion while establishing lush vegetation.
- 4' x 147' rolls (65 sq. yard rolls).

**GEOJUTE, 4' x 147' Roll** Quantity discounts available.

**GEOJUTES, 6" x 11 ga. Staples, 100/box**

**GEOJUTE500, 6" x 11 ga. Staples, 500/box**

**GEOJUTESM, 6" x 11 ga. Staples, 1,000/box**

*Weight counted.*



## SILT FENCE

- 3' x 100' rolls—ready for installation.
- Impedes silt runoff and prevents topsoil from washing away from construction sites.
- Water runoff is controlled by the unique fabric.
- Durable, strong, lightweight, and easy to use.
- Protects streams, lakes, and other waterways from silt buildup.
- Silt fence fabric (SF03X100) with 13 – 4' x 1 1/2" wood stakes attached on 8' centers.

**SF03X100, Silt Fence 3' x 100' w/post**

**SF03X100NP, Silt Fence 3' x 100' w/o post**

Quantity discounts available.



# POND & LAKE MANAGEMENT

## WATERMASTER FLOATING PUMP

*Agri Drain is pleased to be the exclusive U.S. distributor for the Watermaster Floating Pump!*

Move water FAST with the Watermaster Floating Pump! Use it in a variety of applications including floodwater removal from buildings and basements, draining low spots in farm fields and ditches, removing excess water from construction sites and golf courses, and pumping water for fire suppression. The Watermaster can also be used for water aeration and irrigation!

- Discount available when purchasing 6 or more pump packages.
- Pumps approximately 840 gallons per minute, up to 3,000 foot.
- Pumps up to a 30 foot lift.
- Motor can be idled down to reduce flow.
- Quick set-up—set in the water, roll out hose, pull cord, and walk away.
- Watermaster Pumps carry a 1-year warranty (from date of invoice) on defects in material or workmanship for residential, 90 day warranty for commercial use, and no warranty for rental purposes.
- Refer to Kohler or Briggs & Stratton owner's manual for engine warranty.

### Specs:

- Self-priming pump with heavy-duty 5.5 HP, 4 cycle gas engine.
- 1.4 liter (.37 gallon) fuel tank, runs approximately 1 1/2 hours on one tank of fuel.
- Transmission is a 4 to 1 gear reduction, with a screw on 12.5" impeller.
- Corrosion-resistant, fiberglass body.
- Pump measures 20" x 30" and weighs only 80 lbs.
- Water is pumped through a 6"-diameter, 400' discharge hose.
- Check engine and transmission oil levels daily (hydraulic oil recommended, but may also use transmission oil). Engine takes 20 oz. of oil (10W-30), transmission takes 40 oz. (hydraulic).
- Pump Package Includes: Watermaster pump, 6"-diameter 400' hose, and O-ring.

### WATERMASTERPP, Pump Package WATERMASTERHOSE, 400' Hose

Quantity discounts available.

## DRY HYDRANT KITS

- 6" PVC Female Dry Hydrant Adapters with plug, elbow, and either a 4.5" or 6" head.
- 6" Horizontal SCH40 PVC Strainer with back-flushing cover. Strainer meets NFPA 1142 Standards.
- 6" Strainer Support Clamp.
- Flange on the dry hydrant head spins to tighten onto firehose. Female National Hose (NH)/National Standard Thread (NST) specs.

### DH06C, Kit with 4.5" head DH06C6, Kit with 6" head

Quantity discounts available.

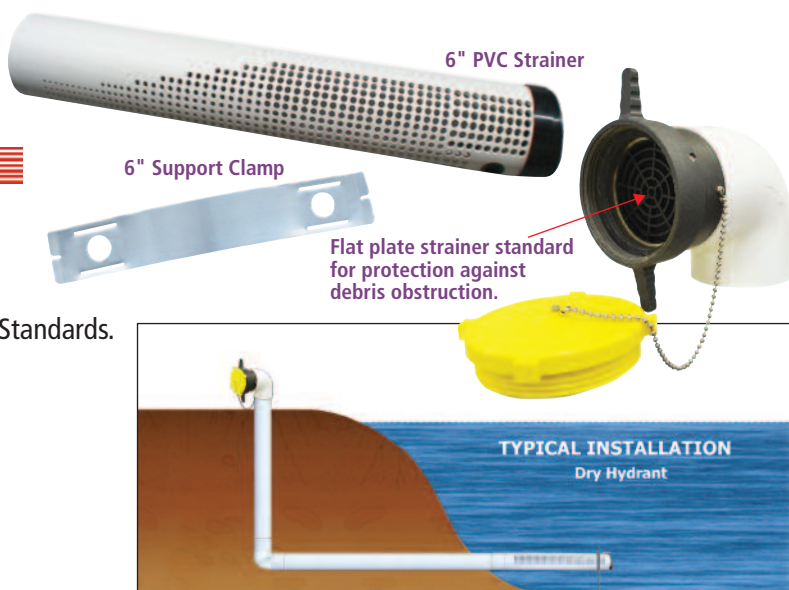

# POND & LAKE MANAGEMENT

## POND & LAKE AERATOR

- Easy to install.
- Improves water clarity, promotes fast fish growth, helps eliminate winter fish kill, and keeps an area ice free for livestock or waterfowl.
- Capable of aerating ponds up to 1.5 acres, and from 3'-20' deep.
- Includes Great Lakes® synergistic 4-diffuser manifold, 1/4-hp diaphragm compressor, pole-mounted lockable aluminum cabinet, 6' power cord, 100' of unweighted tubing, and 15 brick ties that attach to three-hole bricks (not included).

### PLACT



## POND LINERS

*Easy to install & aquatic safe!*

- Wetlands
- Ponds
- Fish hatcheries
- Lagoons
- Animal waste confinements



Call for pricing and details!

More details available online at [www.agridrain.com](http://www.agridrain.com)



## 1000 SERIES

*Designed for farm ponds and small bodies of water.*

- Floating dock sections have an anti-skid surface.
- Easy connections make for unlimited deck shape variations. (Poles not included.)
- All parts have an 8-year manufacturer's warranty.



## 2000 SERIES

*Designed for fluctuating and large bodies of water.*

- Made of durable polyethylene plastic: resists fading, UV rays, gas, oil, and salt water.
- All parts have an 8-year manufacturer's warranty.

Refer to website for full product listing and details.



## CLEAN CHECK EXTENDABLE BACKWATER VALVES

*Prevent sewage backup into a residence or building.*

- Easily installed outside a home, business, or other structure without using a costly man-hole, and are readily

accessible for maintenance or cleaning.

- Perform maintenance and inspection from ground level.
- Kit includes: tee-shaped valve body, top collar and bottom collar with replaceable PVC flapper attached.
- Attaches to SCH40 PVC, direct bury up to 12' deep, available in 4" and 6" PVC.

ADCLEANCK4, 4"    ADCLEANCK6, 6"

# Agri Drain

CORPORATION

## Improve Water Quality

Increase Yields | Conserve Water | Reduce Nutrient Loss

*Manufacturer and supplier of products you need to get the job done.*

- Drainage Water Management
- Sub-irrigation ■ Wetlands
- Ponds ■ Erosion Control
- Land Improvement

Agri Drain has teamed up with Ecosystem Services Exchange to offer planning, design, management, and products for conservation practices.

Call ESE for technical assistance & FREE site review, then call Agri Drain for the products to get the job done!

**800-232-4742**

[www.agridrain.com](http://www.agridrain.com)    [www.ecoexch.com](http://www.ecoexch.com)

**ESE**  
Ecosystem Services Exchange  
*Valuing Conservation*

*Working with your contractor to provide:*

- Conservation planning and water management system design.
- Drainage and sub-irrigation system design.
- Saturated buffer and bioreactor plans.

All plans meet NRCS standards. USDA financial assistance available to qualified landowners.

# Agri Drain CORPORATION

P.O. Box 458  
1462 340th Street  
Adair, Iowa 50002

**FACTORY DIRECT!**

If there are any changes, additions, or deletions to the mailing label above, let us know by calling 1-800-232-4742.

## COMMITTED TO OUR CUSTOMERS SINCE 1976!

- Call Agri Drain for all your drainage needs!
- Large inventory available!
- Purchase **FACTORY DIRECT!**
- We are here and ready to serve you!



Water Quality  
Inlets—pg. 20



Heavy Duty  
Bar Guards—pg. 16



Heavy Traffic  
Grates—pg. 18



Intake Marker  
Flags—pg. 19



Heavy Duty, Manual Maxi  
Stringer Trailer—pg. 28



Heavy Duty Steel  
Catch Basin—pg. 25



Mild Steel  
Flap Gate—pg. 11

Order online! Log in or call to set up an account today!

You can also stop in, call, fax, or email your order to [info@agridrain.com](mailto:info@agridrain.com).

More products available on our website.

Phone: 800-232-4742 ■ Fax: 800-282-3353  
Outside of the United States: 641-742-5211  
[www.agridrain.com](http://www.agridrain.com) ■ [info@agridrain.com](mailto:info@agridrain.com)



Know what's below.  
Call before you dig.  
Within the US, Call: 811  
[www.call811.com](http://www.call811.com)